

SIEMENS

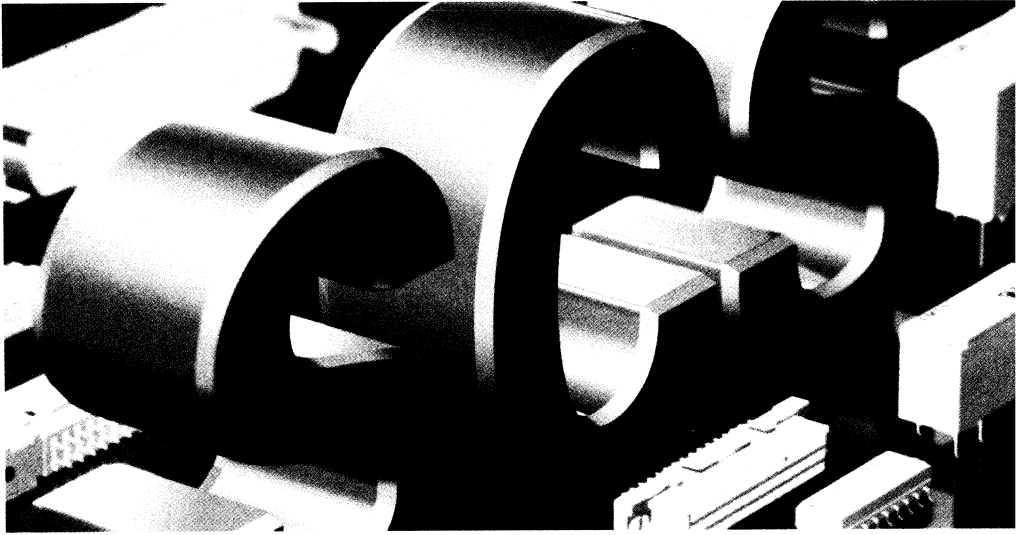

Siemens Components Service

Electromechanical Components

Preferred Products, 1999

The right component is just a mouse click away

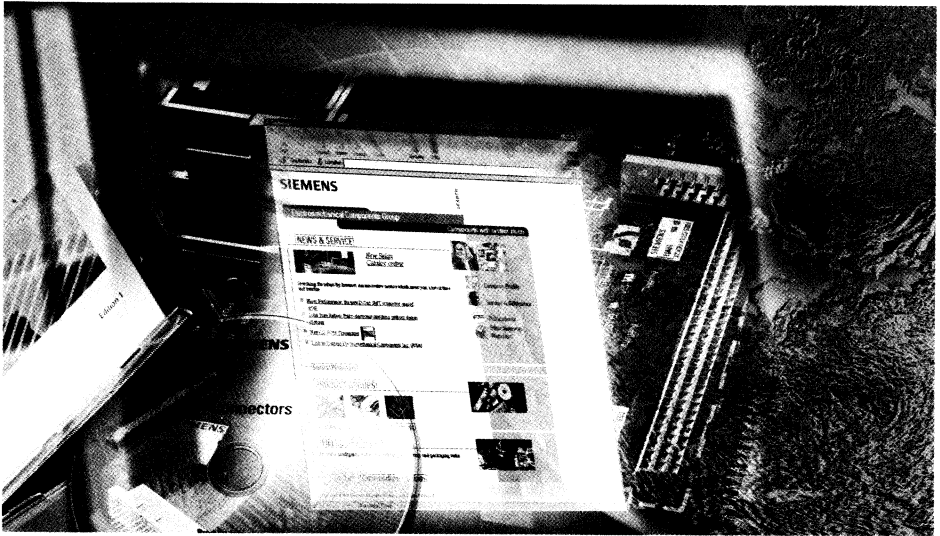

You can now find the components you need in no time at all using CD-ROM or Internet!

CD-ROMs for "Relays" and "Connectors"

Electromechanical Components has listed its entire range of relays, connectors, switches and push buttons on two CD-ROMs with all relevant information and data. There are several possibilities to find the component you need. Both CD-ROMs also set up a direct link to the relevant Internet pages. Online help and notebook function for orders and quotations (pre-addressed fax) offer even more comfort. All EC addresses throughout the world can be viewed directly from the quotation feature.

Both English and German versions are available on each CD-ROM.

Internet: www.siemens.de/ec – the address for Electromechanical Components online

Besides interesting news items, this provides comprehensive information on the company, its divisions and, of course, on the latest product developments. You can also call up the current addresses of branch offices.

The address for fast relay search: www.siemens.de/ec/relay-catalog

A tool helps you with your online search for industrial, telecommunications and automotive relays. Just enter the search criteria and options and you'll be presented with a hit list. Use the order numbers in the list to call up the technical data. This will always provide you with the very latest information as these web pages are regularly up-dated. By visiting EC's web site you will be among the first to be able to incorporate new developments into your own product designs.

Siemens Components Service

Electromechanical Components

Relays

Connectors

Switches and Pushbuttons

Mountings

Circuit Breakers

Acoustic Signalling Devices

Preferred Products

1999

Siemens Components Service

Your distributor in the Benelux

Eurodis Texim Electronics B.V.
Nijverheidsstraat 16
Postbus 172
NL-7480 AD Haaksbergen
Phone + (31) 53 57-33 333
Fax + (31) 53 57-33 888

Eurodis Texim Electronics N.V. / S.A.
Oorlogskruisenlaan 116
Avenue des Croix de Guerre 116
B-1120 Brussel/Bruxelles
Phone + (32) 2-247 49 69
Fax + (32) 2-215 81 02



TEXIM electronics

Your Siemens agency in the Benelux

Siemens Nederland N. V.
Division ECE
Prinses Beatrixlaan 26
Postbus 16068
NL-2500 BB Den Haag
Phone + (31) 70-333 2065
Fax + (31) 70-333 28 15

Siemens Electronic Components
Charleroisesteenweg 116
Chaussée de Charleroi 116
B-1060 Brussel/Bruxelles
Phone + (32) 2-536 23 48
Fax + (32) 2-536 28 57

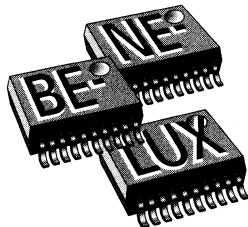

Contents **Page**

Relays **7**

Connectors **119**

Switches and Pushbuttons **199**
Mountings **215**
Circuit Breakers **NEW 217**
Acoustic Signalling Devices **223**

Alphanumerical Index **230**
Terms of Business **233**

Relays

Connectors

Electrom. Components

Appendix

Signs:

- ◆ Components being subject to US reexport licensing if destined for Libya, North Korea, Cuba or Vietnam, but **not** being subject to German export licensing.
- ▽ Components subject to slight variations, e. g. a new revision status: ★★★-B instead of ★★★-A; the components are interchangeable with the previous types.
- ★ Variable digit or letter
- ® Registered trademark

NEW New components in this book

All dimensions are given in mm, unless otherwise specified.
The commas used in the numerical values denote decimal points.

The SCS range of **passive components and electron tubes** is presented in a separate volume titled "Siemens Components Service, Passive Components and Electron Tubes, Preferred Products May 1999", which is available from your local Siemens sales office, agency or distributor.

The product range comprises:

Inductive Ferrite Components
Ferrites und Accessories
Thick-Film Chip Resistors
NTC Thermistors
PTC Thermistors
Varistors
Surge Arresters
Ceramic Capacitors

Film Capacitors
Tantalum Electrolytic Capacitors
Aluminum Electrolytic Capacitors
Capacitors for Power Electronics
EMC Components
Lab Assortments
Voltage Testers
Special-Purpose Tubes

Siemens Components Service

The easy way of ordering your electromechanical components

In the SCS catalog you will find all preferred products from the ranges of relays, connectors, switches and pushbuttons produced by Siemens Electromechanical Components.

The most popular components with their major technical data and order quantities are shown all very clear and easy to refer to.

Please make sure that your order – whether by order form, fax, telex or phone – includes the following details:

- Orderer's address
- Order number and reference
- Type
- Ordering code
- Quantity (observe minimum order quantities and delivery units)
- Price
- Address for delivery
- Required means of shipment

For preferred products you get same day dispatch straight from our speed-delivery warehouses.

What you should also know

The delivery units (DU) are stated in the ordering information for the individual products. Orders for other quantities are rounded to whole delivery units.

Delivery in complete units has the following advantages:

- You receive original packages from the manufacturing plants
- Confusion and damage which may arise from transferring the products from original packing to delivery packing are excluded.

Larger quantities of our products and non-SCS types will be supplied ex works. Inquire for prices and delivery schedules.

Complete service for your order

No matter what you are interested in, at the end of the catalog you will find the address and telephone number of the person who is responsible for taking your orders – and also for providing you with technical information.

And in every case remember: we deliver dependably, speedily and are only too glad to help you with advice.

Environmental Protection – Technology with responsibility

Excerpt from the SIEMENS AG corporation principles

"We feel it is our obligation to protect the environment and to use its natural resources sparingly. This applies to our production processes as well as to our products. The potential subsequent burdens on our environment are to be taken into account, right from the time we start developing our products. It is our aim to avoid environmental pollution or reduce it to a minimum, above and beyond the prevailing regulations."

This means the following, among other things:

- In addition to observing the environmental-protection regulations, we are continuously working on decreasing environmental impacts and energy and resource consumption. Our sites were appraised in 1995/96 by the German Organization for the Certification of Management Systems (DQS) according to the (EC) ordinance 1836/93 of the council of the European Union. The DQS confirmed that the requirements of the ordinance were completely fulfilled.
- Environmental impact are assessed and taken into account at the earliest possible stage of product and process planning. We subject our products to a test for environmental friendliness according to the SIEMENS standard 36350.
- Through suitable environmental management we make sure that our environmental policy is put into practice effectively. The technical and organizational processes necessary for this are checked regularly and continue to be further developed. Our environmental-management system conforms to the requirements of (EC) ordinance no. 1836/93 of the Council of the European Union.
- Environmentally conscious behavior is part of the work of every single staff member. Environmental protection is firmly anchored in our management system, in order to expand and further the sense of responsibility for the environment at all levels.

Relays

Telecom/Signal relays	11
Power relays	54
Solid-state relays	114

New relays in this edition

Small relay, D2 neutral

This monostable relay extends the existing product range by a neutral D2 variant. The D2n product family can be supplied with a range of coils with different sensitivities. A further model complying with the requirements in accordance with British Telecom BT47 (Spec. T4563c) is available as an option. The simple relay design makes it possible to offer a low-cost relay for telecommunications and signal applications.

PT miniature relay

This modern and high-performance miniature relay is available in a number of different versions. Due to a totally different magnetic system it was possible to reduce the coil power consumption while retaining high contact forces. The height was reduced (to 29 mm) and at the same time the switched power rating was increased considerably. In addition to a mechanical operating indicator, a test button has also been integrated allowing universal use in control and mechanical engineering applications. A perfectly harmonized range of accessories is also available.

Miniature power relay T7N

This relay is largely equivalent to the Mini L, which is no longer available. Like its predecessor, the T7N is available in various versions, for example with various contact arrangements and materials.

RT Inrush power PCB relay

The special design of the contact systems of this version of the RT power PCB relay allows the switching of loads characterized by particularly high inrush current peaks (of up to 80 A for 20 ms). These are caused, in particular, by:

- lamps
- compressors and
- motors

With a 400 mW coil and a 16 A normally-open contact, the RT Inrush fits perfectly into the existing RT relay family.

Safety relays SR2M, SR4 and SR6

Relays with forcibly guided contacts in accordance with EN 50205. Switching to the fail-safe state is enabled by safety control circuits, monitored using forcibly guided contacts. This means that the „safety rules for controls on power-operated presses for metalworking (ZH1/457)“ are fulfilled. Large insulation distances are another important safety characteristic. Typical applications are in switching devices, controls and signal systems etc. The relays are available in versions with various contact arrangements (2 ... 6 contacts).

SIEMENS

We'll manage

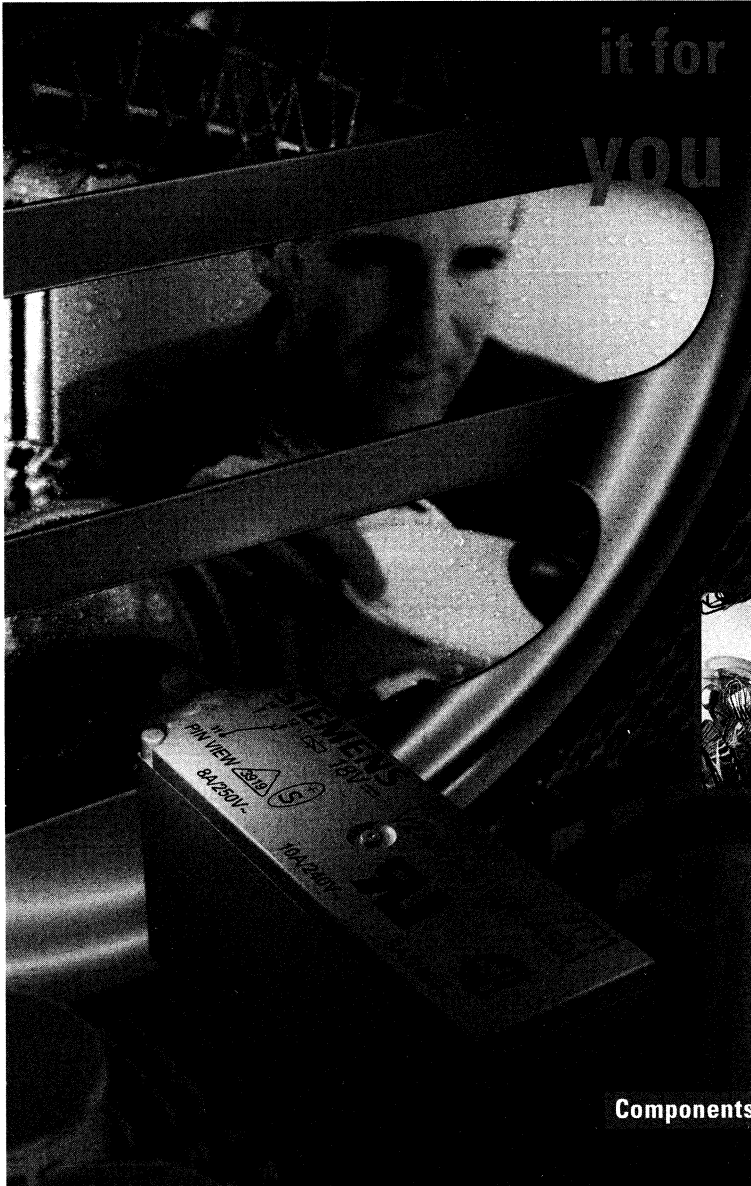

Things get pretty hot on the inside of a dishwasher. So the demands on its heating controls are tough. Our power relays can be relied upon to take care of things – even where transient currents are high. But that's not the only tricky job that Siemens Electro-mechanical Components can handle. From cost-optimized, low-volume solutions to custom controls, we can supply special designs and adaptations for virtually any power electronics application.

Curious?
Then get in touch
with us!



Components with system vision

Relays

Contents	Type	Page
Telecom/Signal relays		
Miniature relays P1	V23026	11
Miniature relays P1-SMD	V23026	13
Miniature relays P2	V23079	15
Miniature relays P2-H	V23106	17
Small relays D1	V23040	18
Small relays D2 neutral	V23105	20
Small relays D4	V23104	22
Small relays W11	V23101	23
Small relays W12	V23100-W12	24
Card relays SN	V23030	25
Cradle relays N	V23154, V23162	29
Cradle relays P	V23003	37
Cradle relays S	V23054	39
Cradle relays W	V23005	41
Cradle relays, Small general-purpose relays, accessories		43
DIP reed relays	V23100-V4	45
Reed relays V6	V23100-V6	48
Small general-purpose relays	V23006	49
Power relays 15	V23009	51
Power relays		
PCB relays		
PE PCB relays	PE	53
Slim power relays (SNR)	V23092	54
RE PCB relays	RE	55
RY II miniature PCB relays	RY2, RY5	56
RY II miniature PCB relays, accessories		58
Miniature power relays MSR	V23061	59
RT Power PCB relays	RT1, RT3, RT4, RTE	61
RT Power PCB relays, bistable	RT3, RT4	64
RT Power PCB relays, 105 °C	RTH	66
RT Inrush power PCB relays	RT33K	67
RT Power PCB relays, accessories		68
RP II/1 PCB relays	RP3, RP4	70
RP 3 SL PCB relays – “Special load”	RP3SL	72
Miniature power relays IF	V23077	73
RP II/2 PCB relays	RP4, RP8	75
RP II PCB relays, accessories		77
Card relays E	V23057	79
Miniature power relays U	V23148-A	82
Miniature power relays UB	V23148-B	84
Miniature power relays N	V23016	86
Miniature power relays T7N	SIE:T7N	90
Power relays T9A	POT:T9A	92

Relays

Contents	Type	Page
Power relays		
Industry relays		
ZT Miniature relays	ZT2, ZT5	94
PT Miniature relays	PT2, PT3, PT5	96
ZT/PT Miniature relays, accessories		98
MT multimode relays	MT2, MT3	101
MT multimode relays, accessories		103
Power relays T92	POT:T92	106
Safety relays		
Safety relays SR2M	V23047	109
Safety relays SR4	V23049	111
Safety relays SR6	V23050	113
Solid-state relays		
Solid-state relays	V23100-S, V23107-S	114

Other technical documents and information on our overall product range

A variety of catalogs and product information brochures (infos are available through your trade sales representative)

CD-ROM "Relays", ordering code A23001-G10-D012-X-7400

EC relays in the Web: <http://www.siemens.de/ec/ecr>

Miniature Relays P1

- V23026-A1** ★★★ monostable, 1 winding
- B1** ★★★ bistable, 2 windings
- C1** ★★★ bistable, 1 winding

For dc operation, polarized
 1 changeover contact, bifurcated
 Suitable for ultrasonic cleaning
 Printed circuit terminals
 Pin arrangement for 2,54 mm grid in acc.
 with EN 60097 and DIN 40803

Approvals: UL, CSA, CECC

Approx. weight 1,8 g

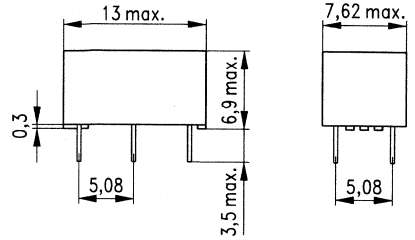

ECR0668-9

Contact ratings:

- Max. switching voltage 150 Vdc/125 Vac
- Max. switching current 1 A
- Max. continuous current 1 A
- Max. power rating 30 W/60 VA

Contact material: palladium nickel, gold-plated, rhodium-coated

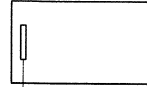

Orientation mark (imprinted)

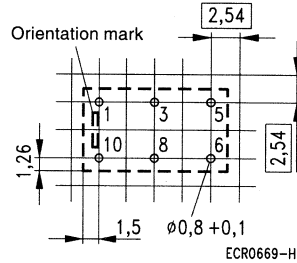

ECR0669-H

Mounting hole layout
View from the wiring side

Base terminals

Monostable and bistable (1 winding)

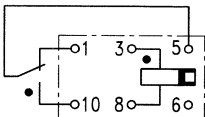

ECR0670-K

Circuit symbols drawn in OFF position.
 If a positive potential is applied to terminal 3,
 the relay assumes the ON position.

Bistable (2 windings)

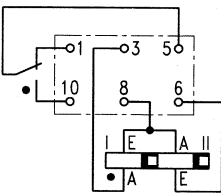

ECR0671-T

Circuit symbols drawn in OFF position.
 If a positive potential is applied to terminal 3
 or a negative potential to terminal 6 as against
 terminal 8, the relay assumes the ON position.

Miniature Relays P1

Rated voltage	Voltage range at 20 °C	Coil resistance at 20 °C ± 10 % Ω	Ordering code	DU										
Vdc	Vdc		V23026-	Pcs										
1 winding, monostable														
5	3,75 ... 14,5	370	A1001-B201	40										
12	9 ... 35	2250	A1002-B201	40										
15	11,25 ... 42	3100	A1003-B201	40										
24	18 ... 50	4500	A1004-B201	40										
2 windings, (I and II, with identical technical data), bistable														
5	3,75 ... 14,75	390	B1101-B201	40										
12	9 ... 29	1500	B1102-B201	40										
1 winding, bistable														
5	3,75 ... 20	740	C1051-B201	40										
12	9 ... 50	4500	C1052-B201	40										
15	11,25 ... 50	4500	C1053-B201	40										

Delivery mode: bar magazine

- V23026-D1** ★★★ monostable, 1 winding
- E1** ★★★ bistable, 2 windings
- F1** ★★★ bistable, 1 winding

For dc operation, polarized
 1 changeover contact, bifurcated
 Suitable for ultrasonic cleaning
 Suitable for automatic placement
 (e. g. on Siemens HS-180); in bar
 magazines or tape (for quantities
 exceeding 480 components)
 by special request

Approvals: UL, CSA
 Approx. weight 1,8 g

Permissible soldering methods

- Max. soldering temperature and time
- Vapor phase soldering: 215 °C; 40 s
 - Infrared soldering: 215 °C; 40 s
 - Dual wave soldering: 260 °C; 10 s

Contact ratings:

- | | |
|-------------------------|-----------------|
| Max. switching voltage | 150 Vdc/125 Vac |
| Max. switching current | 1 A |
| Max. continuous current | 1 A |
| Max. power rating | 30 W/ 60 VA |

Contact material: palladium nickel
 gold-plated,
 rhodium-coated

Base terminals

Monostable and bistable (1 winding)

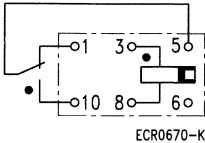

Circuit symbols drawn in OFF position.
 If a positive potential is applied to terminal 3,
 the relay assumes the ON position.

Bistable (2 windings)

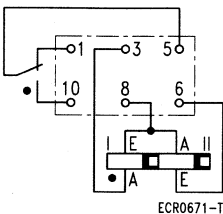

Circuit symbols drawn in OFF position.
 If a positive potential is applied to terminal 3
 or a negative potential to terminal 6 as against
 terminal 8, the relay assumes the ON position.

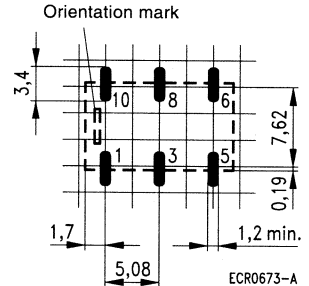
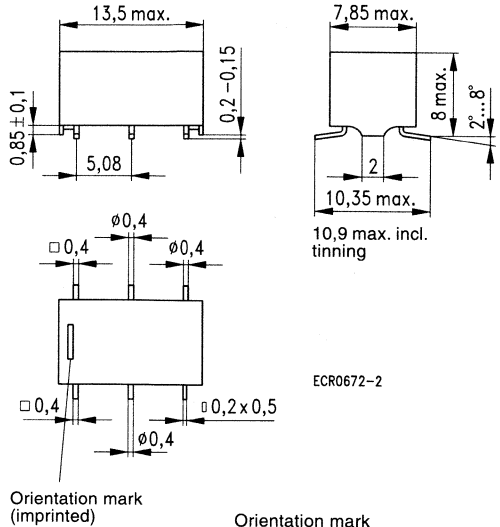

Rated voltage	Voltage range at 20 °C	Coil resistance at 20 °C ± 10 % Ω	Ordering code	DU										
Vdc	Vdc		V23026-	Pcs										

1 winding, monostable

5	3,75 ... 14,5	370	D1021-B201	40										
12	9 ... 35	2250	D1022-B201	40										
15	11,25 ... 42	3100	D1023-B201	40										
24	18 ... 50	4500	D1024-B201	40										

2 windings, (I and II, with identical technical data), bistable

5	3,75 ... 14,75	390	E1101-B201	40										
12	9 ... 29	1500	E1102-B201	40										

1 winding, bistable

5	3,75 ... 20	740	F1051-B201	40										
12	9 ... 50	4500	F1052-B201	40										
15	11,25 ... 50	4500	F1053-B201	40										

Delivery mode: bar magazine with 40 components or, upon request, tape for quantities above 480 components.

Miniature Relays P2

V23079-A1★★★★ monostable, 1 winding

-**B1**★★★★ bistable, 2 windings

-**C1**★★★★ bistable, 1 winding

For dc operation, polarized
 2 changeover contacts, bifurcated
 Immersion cleanable
 Printed circuit terminals
 Pin arrangement for 2,54 mm grid in
 acc. with EN 60097 and DIN 40803, average

Approvals: UL, CSA

Approx. weight 3 g

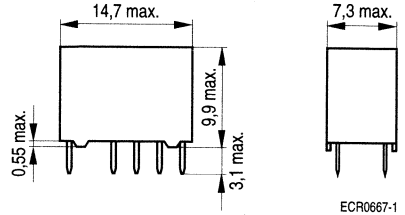

Monostable and bistable, 1 winding

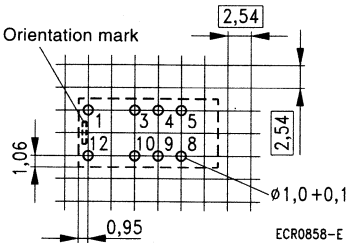

Bistable, 2 windings

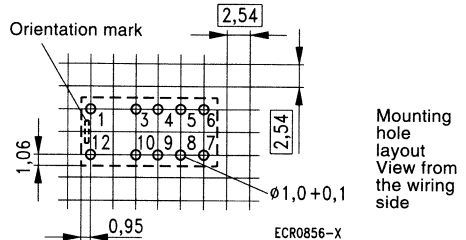

Base terminals

Monostable and bistable, 1 winding

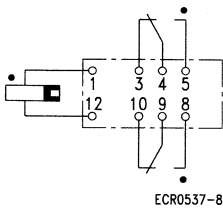

Bistable, 2 windings

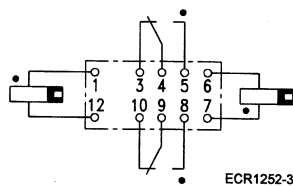

Circuit symbols drawn in OFF position.
 If a positive potential is applied to terminal 1,
 the relay assumes the ON position.

Circuit symbols drawn in OFF position.
 If a positive potential is applied to terminal 1 or 7,
 the relay assumes the ON position.

Contact ratings:

Max. switching voltage 220 Vdc/250 Vac

Max. switching current 2 A

Max. continuous current 2 A

Max. power rating ≥ 60 W/62,5 VA

Contact material: silver-palladium, gold-plated, to silver-palladium

Miniature Relays P2

Rated voltage	Voltage range at 20°C	Coil resistance at 20°C ± 10 % Ω	Ordering code	DU										
Vdc	Vdc		V23079-	Pcs										
1 winding, monostable														
5	3,75 ... 10,90	178	A1001-B201	50										
12	9 ... 26,15	1029	A1003-B201	50										
24	18 ... 52,30	4114	A1005-B201	50										
2 windings, (I and II, with identical technical data), bistable														
5	3,75 ... 10,90	178	B1201-B201	50										
12	9 ... 26,15	1029	B1203-B201	50										
24	18 ... 52,30	4114	B1205-B201	50										
1 winding, bistable														
5	3,75 ... 15,33	357	C1101-B201	50										
12	9 ... 37,00	2057	C1103-B201	50										
24	18 ... 74,00	8228	C1105-B201	50										

Miniature Relays P2-H

V23106-J2★★★ monostable, 1 winding
-L2★★★ bistable, 1 winding

For dc operation, polarized
 2 changeover contacts, bifurcated
 Immersion cleanable
 Printed circuit terminals
 Pin arrangement for 2,54 mm grid in
 acc. with EN 60097 and DIN 40803

Approvals: CSA, UL
 Approx. weight 1,5 g

Contact ratings:

Max. switching voltage 220 Vdc/250 Vac
 Max. switching current 1 A
 Max. continuous current 1 A
 Max. power rating 30 W/62,5 VA

Contact material: silver-palladium, gold-plated,
 to silver-palladium

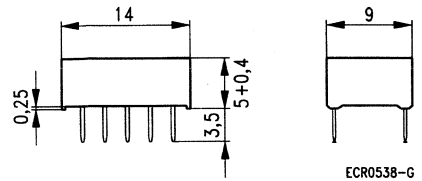

ECR0538-G

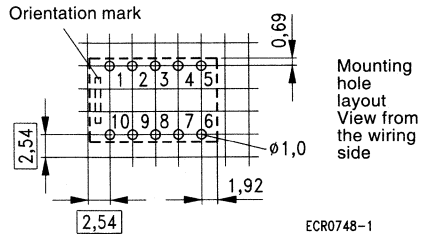

Mounting hole layout
 View from the wiring side

ECR0748-1

Relays

Base terminals

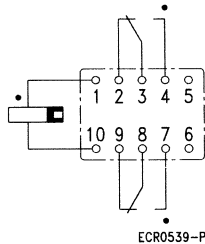

Circuit symbols drawn in OFF position.
 If a positive potential is applied to terminal 1,
 the relay assumes the ON position.

Rated voltage	Voltage range at 20 °C	Coil resistance at 20 °C ± 10 %	Ordering code	DU					
Vdc	Vdc	Ω	V23106-	Pcs					
1 winding, monostable									
5	3,75 ... 12,5	178	J2001-B201	40					
12	9 ... 30	1028	J2003-B201	40					
24	18 ... 48	2880	J2005-B201	40					
1 winding, bistable									
5	3,75 ... 14,5	250	L2101-B201	40					
12	9 ... 34,8	1440	L2103-B201	40					
24	18 ... 57,6	3840	L2105-B201	40					

Small Relays D1

- V23040-A** ★★★ monostable, 1 winding
- B** ★★★ bistable, 2 windings
- C** ★★★ bistable, 1 winding

For dc operation, polarized
 1 changeover contact, bifurcated
 Immersion cleanable
 Printed circuit terminals
 Pin arrangement for 2,5 mm and
 2,54 mm grid in acc. with EN 60097
 and DIN 40803

Approvals: UL, CSA

Approx. weight 6 g

Contact ratings:

Max. switching voltage	150 Vdc/125 Vac
Max. switching current	2 A
Max. continuous current	2 A
Max. power rating	35 ... 60 W (voltage-dependent) 60 VA

Contact material: palladium nickel, gold-plated, rhodium-coated

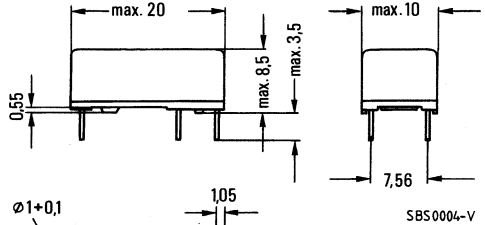

Mounting hole layout
 View from the wiring side

Base terminals

Monostable and bistable (1 winding)

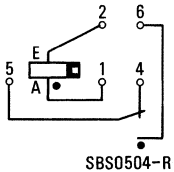

Circuit symbols drawn in OFF position.
 If a positive potential is applied to the start of the winding, the relay assumes the ON position.

Bistable (2 windings)

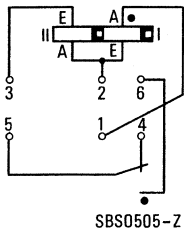

Circuit symbols drawn in OFF position.
 If a negative potential is applied to terminal 1 or a positive potential to terminal 3 as against terminal 2, the relay assumes the OFF position.
 If a positive potential is applied to terminal 1 or a negative potential to terminal 3 in relation to terminal 2, the relay assumes the ON position.

Small Relays D1

Rated voltage	Voltage range at 20 °C	Coil resistance at 20 °C ± 15 % Ω	Ordering code	DU											
Vdc	Vdc		V23040-	Pcs											
1 winding, monostable															
5	3,75 ... 16,5	320 ²⁾	A1-B201	25											
12	9 ... 30	1140	A2-B201	25											
15	11,25 ... 38	1850	A3-B201	25											
24	18 ... 60	4370	A4-B201	25											
2 windings, (I and II, with identical technical data), bistable															
5	3,75 ... 16	315	B101-B201	25											
12	9 ... 30	1110	B102-B201	25											
15	11,25 ... 37	1760	B103-B201	25											
24 ¹⁾	18 ... 46	2800	B104-B201	25											
1 winding, bistable															
5	3,75 ... 20	500	C51-B201	25											
12	9 ... 38	1850	C52-B201	25											

1) Continuous energizing at rated voltage only permissible up to an ambient temperature of 60 °C.
 2) ± 10 %

- V23105-A50**★★ monostable,
1 winding, 150 mW
- V23105-A53**★★ monostable,
1 winding, 200 mW
- V23105-A54**★★ monostable,
1 winding, 400 mW
- V23105-A55**★★ monostable,
1 winding, 500 mW
- V23105-A547**★★ monostable,
1 winding, BT47-types (current-controlled)

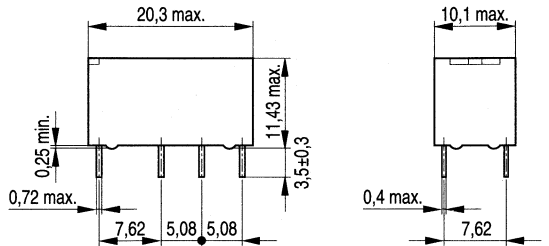

ECR0920-3

For dc operation, neutral
2 changeover contacts
Immersion cleanable, printed circuit terminals
Pin arrangement for 2,54 mm grid in
acc. with EN 60097 and DIN 40803

High-voltage resistance in acc. with FCC Part 68

Approvals: UL, CSA, BT47

Approx. weight 6 g

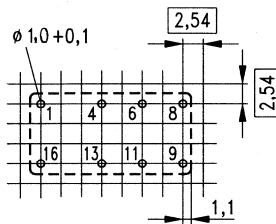

ECR1541-6

Mounting hole layout
View from the wiring side

Contact ratings:

- Max. switching voltage 150 Vdc/150 Vac
- Max. switching current 2 A
- Max. continuous current 3 A
- Max. power rating 60 W/120 VA

Contact material Silver palladium, gold-plated,
to silver palladium, gold-plated

Base terminals

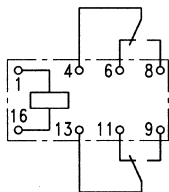

ECR0836-1

Rated voltage	Voltage range at 20°C	Coil resistance at 20°C ± 10 % Ω	Ordering code	DU							
Vdc	Vdc		V23105-	Pcs							

150 mW rated power consumption

5	4 ... 11,5	167	A5001-A201	25							
12	9,6 ... 27,6	960	A5003-A201	25							
24	19,2 ... 55,2	3480	A5005-A201	25							

200 mW rated power consumption

5	3,5 ... 9,7	125	A5301-A201	25							
12	8,4 ... 23,2	720	A5303-A201	25							
24	16,8 ... 46,5	2880	A5305-A201	25							

400 mW rated power consumption

5	3,5 ... 7,9	62	A5401-A201	25							
12	8,4 ... 18,9	360	A5403-A201	25							
24	16,8 ... 37,9	1440	A5405-A201	25							

500 mW rated power consumption

5	3,5 ... 7,5	36	A5501-A201	25							
12	8,4 ... 18,0	280	A5503-A201	25							
24	16,8 ... 36,0	1050	A5505-A201	25							
48	33,6 ... 72,0	4000	A5507-A201	25							

Rated voltage	Operating current	Coil resistance at 20°C ± 10 % Ω	Ordering code	DU							
Vdc	mA		V23105-	Pcs							

BT47-types (current-controlled)

12	27,0	280	A5476-A201	25							
24	14,0	1050	A5477-A201	25							

Small Relays D4

V23104-A★★★

For dc operation, neutral, monostable
 4 changeover contacts, bifurcated
 Immersion cleanable
 Printed circuit terminals
 Pin arrangement for 2,54 mm grid in acc.
 with EN 60097 and DIN 40803, average
 Approx. weight 7 g

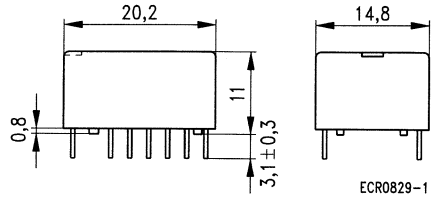

Contact ratings:

- Max. switching voltage 150 Vdc/
150 Vac
- Max. switching current 1,25 A
- Max. continuous current 2 A
- Max. power rating 30 W/50 VA
- Contact material: silver/nickel 20
gold-plated

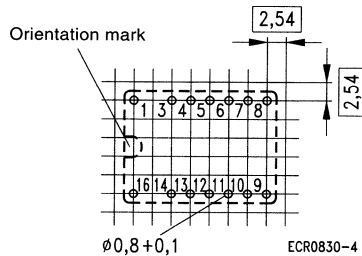

Mounting hole layout
View from the wiring side

Base terminals

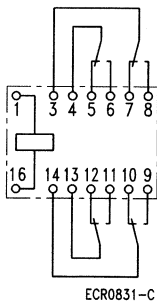

Rated voltage	Voltage range at 20 °C	Coil resistance at 20 °C ± 10 %	Ordering code	DU						
Vdc	Vdc	Ω	V23104-	Pcs						
5	3,6 ... 8,65	83	A1001-B101	25						
12	8,6 ... 20,8	480	A1003-B101	25						
24	17,1 ... 41,6	1920	A1005-B101	25						
48	34,1 ... 83,2	7680	A1007-B101	25						

Small Relays W11

V23101-D★★★

For dc operation, neutral, monostable
 1 changeover contact
 Standard or sensitive
 Immersion cleanable
 Printed circuit terminals
 Pin arrangement for 2,54 mm grid in acc.
 with EN 60097 and DIN 40803, average

Approx. weight 4 g

Contact ratings:

Max. switching voltage 60 Vdc /125 Vac
 Max. switching current max. 2 A
 Max. continuous current 1 A
 Max. power rating 30 W/60 VA
 Contact material: silver/palladium,
 gold-plated

Base terminals

Ordering code block 3

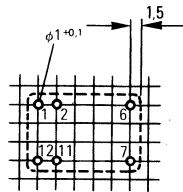
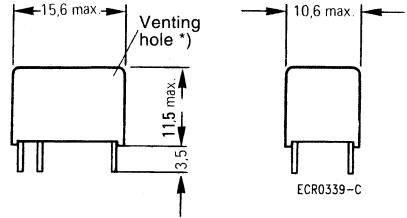

Mounting hole layout
View from the wiring side

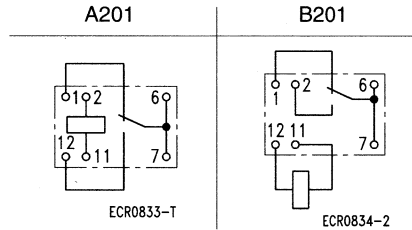

*) After soldering and cleaning, the venting hole is to be punctured with a pin.

Rated voltage	Voltage range at 20 °C	Coil resistance at 20 °C ± 10 %	Ordering code	DU					
Vdc	Vdc	Ω	V23101-	Pcs					

Standard version

5	3,5 ... 7,1	56	D3-A201	25					
12	8,4 ... 16,8	320	D6-A201	25					
24	16,8 ... 33,6	1280	D7-A201	25					
5	3,5 ... 7,1	56	D3-B201	25					
12	8,4 ... 16,8	320	D6-B201	25					
24	16,8 ... 33,6	1280	D7-B201	25					

Sensitive version

5	3,75 ... 10	120	D103-A201	25					
12	9,0 ... 24	700	D106-A201	25					
24	18,0 ... 48	2800	D107-A201	25					
5	3,75 ... 10	120	D103-B201	25					
12	9,0 ... 24	700	D106-B201	25					
24	18,0 ... 48	2800	D107-B201	25					

Small Relays W12

V23100-W12★★

For dc operation, neutral, monostable
 1 or 2 changeover contacts
 Printed circuit terminals
 Pin arrangement for 2,54 mm grid
 (only version with 1 changeover contact)
 in acc. with EN 60097 and DIN 40803, average
 Approx. weight 8 g

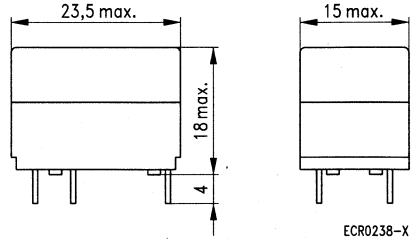

Base terminals

1 changeover contact

2 changeover contacts

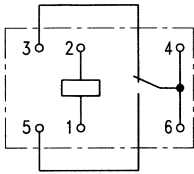

ECR0838-Z

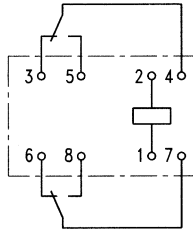

ECR0840-B

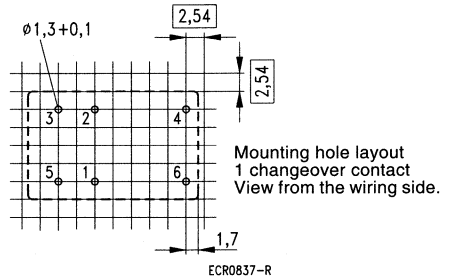

Contact ratings:

Max. switching voltage 125 Vdc / 250 Vac
 Max. switching current 3 A
 Max. continuous current 6 A (21) / 4 A (21 - 21)
 Max. power rating 85 W/360 VA

Contact material: silver, gold-plated

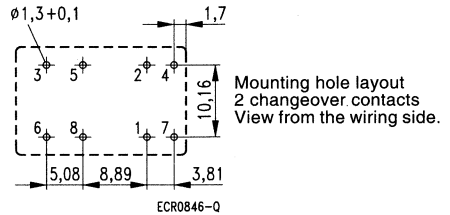

Rated voltage	Voltage range at 20 °C	Coil resistance at 20 °C ± 10 %	Ordering code	DU					
Vdc	Vdc	Ω	V23100-	Pcs					
1 changeover contact									
5	4 ... 6,5	58	W1205-A103	50					
12	9,6 ... 19	300	W1212-A103	50					
24	19,2 ... 38	1250	W1224-A103	50					
2 changeover contacts									
5	4 ... 7,5	42	W1205-A104	50					
12	9,6 ... 18	230	W1212-A104	50					
24	19,2 ... 36	960	W1224-A104	50					

Card Relays SN

- V23030-A1*** without earth terminal
- A2*** with earth terminal
- H1*** without earth terminal, immersion cleanable
- H2*** with earth terminal, immersion cleanable

For dc operation, neutral, monostable
 4 changeover contacts, bifurcated
 Printed circuit terminals
 Pin arrangement for 2,5 mm and 2,54 mm grid
 in acc. with EN 60097 and DIN 40803, fine

Approval: UL
 Approx. weight 25 g

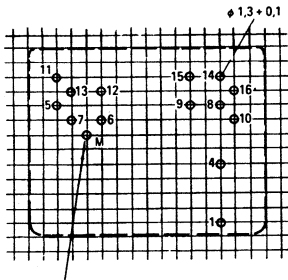
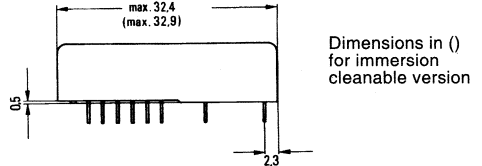
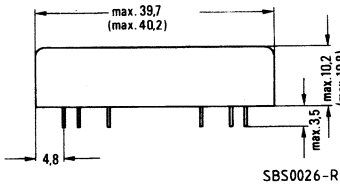

Hole for earth terminal

Mounting hole layout
 View from the wiring side

Base terminals

M = Earth terminal

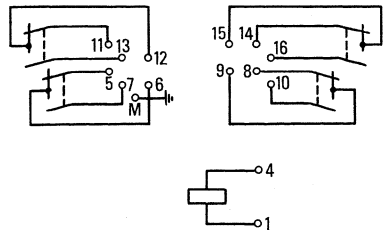

SBS0416-9

Contact ratings:

- Max. switching voltage 250 Vdc/ac
- Max. switching current 3 A¹⁾
- Max. continuous current 1 A (up to 70 °C) / 2 A (up to 50 °C)
- Max. power rating 40 ... 75 W (voltage-dependent) / 100 VA
- Contact material: silver, gold-flashed

1) The current of 3 A may flow for a maximum of 4 seconds up to 10 % on-time.

Card Relays SN

Rated voltage	Voltage range at 20 °C	Coil resistance at 20 °C ± 10 % Ω	Ordering code	DU						
Vdc	Vdc		V23030-	Pcs						

Dust-protected

48	32 ... 88	2700 ¹⁾	A1026-A104	5						
12	7,8 ... 24	185	A2017-A104	5						
24	15,5 ... 47	730	A2021-A104	5						

Immersion cleanable

12	7,8 ... 24	185	H1017-A104	5						
24	15,5 ... 47	730	H1021-A104	5						
24	15,5 ... 47	730	H2021-A104	5						

1) ± 15 %

Card Relays SN

- V23030-C1★★★ without earth terminal
- C2★★★ with earth terminal
- J2★★★ with earth terminal, immersion cleanable

For dc operation, neutral, monostable
 6 changeover contacts, bifurcated
 Printed circuit terminals
 Pin arrangement for 2,5 mm and 2,54 mm grid
 in acc. with EN 60097 and DIN 40803, fine

Approval: UL

Approx. weight 30 g

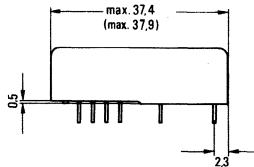
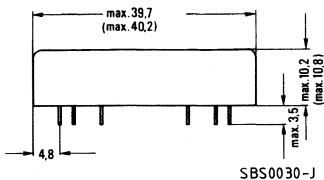

Dimensions in ()
 for immersion
 cleanable version

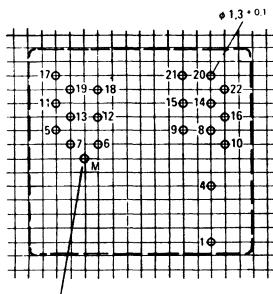

Hole for earth terminal

Mounting hole layout
 View from the wiring side

Base terminals

M = Earth terminal

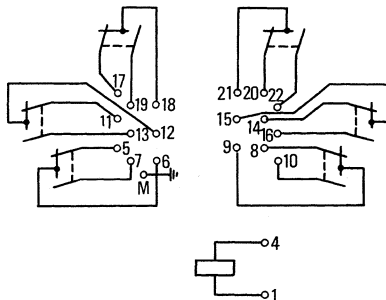

SBS0417-H

Contact rating:

- Max. switching voltage 250 Vdc/ac
- Max. switching current 3 A¹⁾
- Max. continuous current 1 A (up to 70 °C) / 2 A (up to 50 °C)
- Max. power rating 40 ... 75 W (voltage-dependent) / 100 VA

Contact material: silver, gold-flashed

1) The current of 3 A may flow for a maximum of 4 seconds up to 10 % on-time.

Card Relays SN

Rated voltage	Voltage range at 20°C	Coil resistance at 20°C ± 10 % Ω	Ordering code	DU						
Vdc	Vdc		V23030-	Pcs						

Dust-protected

12	9,5 ... 24	185	C1017-A106	5						
24	18,5 ... 47	730	C1021-A106	5						
24	18,5 ... 47	730	C2021-A106	5						

Immersion cleanable

24	18,5 ... 47	730	J2021-A106	5						
----	-------------	-----	------------	---	--	--	--	--	--	--

Cradle Relays N

Size I
V23154-C★★★★

For dc operation
 neutral, monostable,
 Plug-in plus screw fixing

Approx. weight 20 g

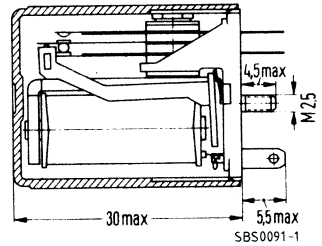
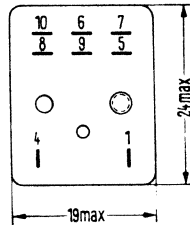

Base terminals

Ordering code block 3	B104	C104
Type of contact	single	bifurcated
Contact arrangement	21-21	
Symbols with base connections		

Mounting hole layout

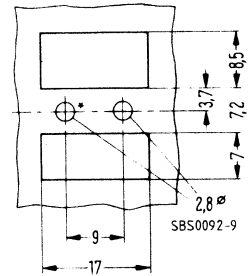

* This hole is omitted if the mounting hole layout is intended for the socket.

Contact ratings:

Max. switching voltage 150 Vdc/125 Vac
 Max. switching current 2 A
 Max. power rating 35 ... 70 W (voltage-dependent) / 50 VA
 Contact material: silver, gold-flashed

Voltage range at 20°C	Coil resistance at 20°C ± 10 %	Ordering code	DU						
Vdc	Ω	V23154-	Pcs						

Single contacts

13 ... 40	890	C721-B104	5						
27,6 ... 75	3200 ¹⁾	C726-B104	5						

Bifurcated contacts

13 ... 32	550	C720-C104	5						
-----------	-----	-----------	---	--	--	--	--	--	--

1) ± 15 %

Cradle Relays N

Size II
V23154-D***

For dc operation
 neutral, monostable,
 Plug-in plus screw fixing

Approx. weight 25 g

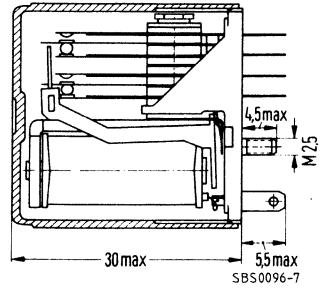
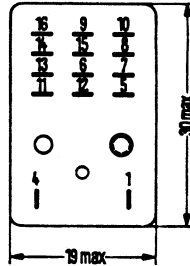

Mounting hole layout

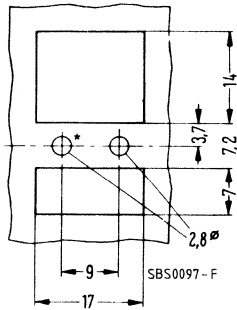

* This hole is omitted if the mounting hole layout is intended for the socket.

Base terminals

Ordering code block 3	C112	B110 B610	C110	F104
Type of contact	bifurcated contacts	single contacts	bifurcated cont.	single contacts
Contact arrangement	1-1-1-1-1-1	21-21-21-21		21-21
Symbols with base connections				

Cradle Relays N

Ordering code block 3	B1 .. or C1 ..	F1 ..
Contact material	silver, gold-flashed	silver, gold-flashed
Contact ratings:		
Max. switching voltage	150 Vdc/125 Vac	250 Vdc/ac
Max. switching current	2 A	5 A
Max. power rating	35 ... 70 W (voltage-dependent) 50 VA	50 ... 140 W (voltage-dependent) 500 VA

Voltage range at 20 °C	Coil resistance at 20 °C ± 10 %	Ordering code	DU										
Vdc	Ω	V23154-	Pcs										

Single contacts

8,3 ... 20	220	D717-F104	5										
12,5 ... 32	550	D720-B110	5										
12,5 ... 32	550	D720-F104	5										
17 ... 40	890	D721-B110	5										
17 ... 40	890	D721-F104	5										
35 ... 75	3200 ¹⁾	D726-B110	5										

Bifurcated contacts

20 ... 32	550	D720-C110	5										
-----------	-----	-----------	---	--	--	--	--	--	--	--	--	--	--

1) ± 15 %

Cradle Relays N

Size I

V23154-M★★★

For dc operation
neutral, monostable
Printed circuit terminals

Pin arrangement for 2,5 mm and
2,54 mm grid in acc. with DIN EN 60097
and DIN 40803, average

Approx. weight 20 g

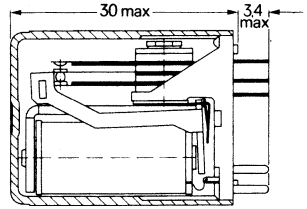
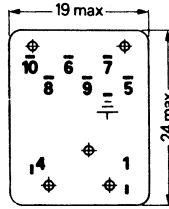

Size II

V23154-N★★★

For dc operation
neutral, monostable
Printed circuit terminals

Pin arrangement for 2,5 mm and
2,54 mm grid in acc. with DIN 40801
and DIN 40803, average

Approx. weight 25 g

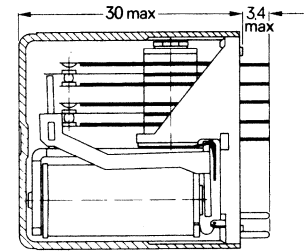
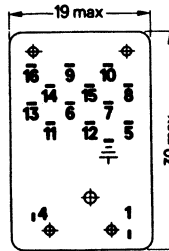

SBS0101 - C

Mounting hole layout

Size I

Size II

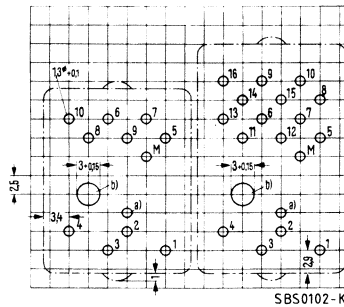

View from the wiring side

M = >Earth terminal

- a) Holes for mechanical armature actuation, if required
- b) Holes for fixing the socket by means of M1,6 screws, if required

Cradle Relays N

Base terminals

Ordering code block 3	B104	B110
Type of contact	single contacts	single contacts
Contact arrangement	21-21	21-21-21-21
Symbol with base connections		

Contact ratings:

Max. switching voltage 150 Vdc/125 Vac
 Max. switching current 2 A
 Max. power rating 25 ... 70 W (voltage-dependent) / 50 VA
 Contact material: silver, gold-flashed

Voltage range at 20°C Vdc	Coil resistance at 20°C ± 10 % Ω	Ordering code V23154-	DU							
			Pcs							
9,8 ... 32	550	M720-B104	5							
13 ... 40	890	M721-B104	5							
10 ... 24	325	N719-B110	5							
12,5 ... 32	550	N720-B110	5							

Relays

Cradle Relays N

Size I

V23162-A★★★ for dc operation

neutral, monostable
Hermetically sealed
Plug-in plus screw fixing

Approx. weight 30 g

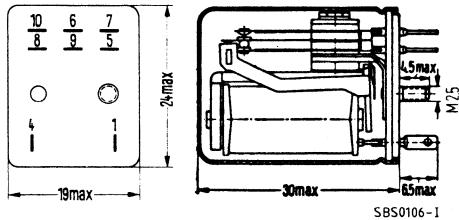

Base terminals

Ordering code block 3	B104	C104
Type of contact	single	bifurcated
Contact arrangement	21-21	
Symbols with base connections		

Mounting hole layout

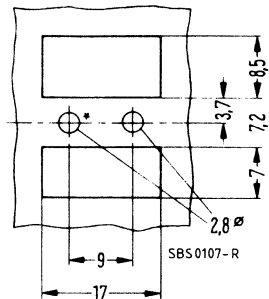

* This hole is omitted if the mounting hole layout is intended for the socket

Contact ratings:

Max. switching voltage 150 Vdc/125 Vac

Max. switching current 2 A

Max. power rating 35 ... 70 W (voltage-dependent) / 50 VA

Contact material: silver, gold-flashed

Voltage range at 20°C	Coil resistance at 20°C ± 10 %	Ordering code	DU						
Vdc	Ω	V23162-	Pcs						

Single contacts

13 ... 40	890	A721-B104	5						
-----------	-----	-----------	---	--	--	--	--	--	--

Bifurcated contacts

17,5 ... 40	890	A721-C104	5						
-------------	-----	-----------	---	--	--	--	--	--	--

Cradle Relays N

Size II

V23162-B★★★

With tinned contact blades

For dc operation, neutral, monostable

Hermetically sealed

Plug-in plus screw fixing

Approx. weight 35 g

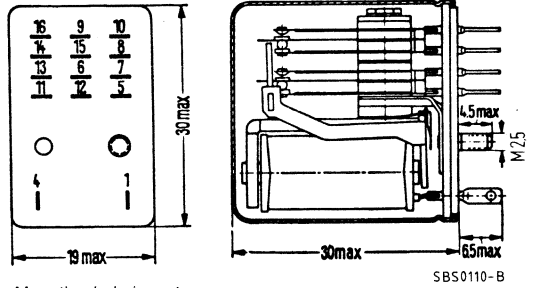

Mounting hole layout

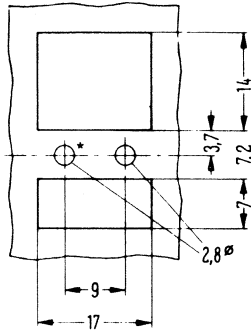

* This hole is omitted if the mounting hole layout is intended for the socket

Base terminals

Ordering code block 3	B110	F104
Type of contact	single contacts	single contacts
Contact arrangement	21-21-21-21	21-21
Symbols with base connections	<p>SBS0111-J</p>	<p>SBS0112-S</p>

Cradle Relays N

Ordering code block 3	B1 ..	F1 ..
Contact material	silver, gold-flashed	silver, gold-flashed
Contact ratings: Max. switching voltage Max. switching current Max. power rating	150 Vdc/125 Vac 2 A 35 ... 70 W (voltage-dependent) 50 VA	250 Vdc/ac 5 A 50 ... 140 W (voltage-dependent) 500 VA

Voltage range at 20 °C	Coil resistance at 20 °C ± 10 %	Ordering code	DU						
Vdc	Ω	V23162-	Pcs						
17 ... 40	890	B721-B110	5						
17 ... 40	890	B721-F104	5						
35 ... 75	3200 ¹⁾	B726-B110	5						

1) ± 15 %

Cradle Relays P

Size I V23003-A★★★

For dc operation, polarized, bistable
Plug-in plus screw fixing

Approx. weight 20 g

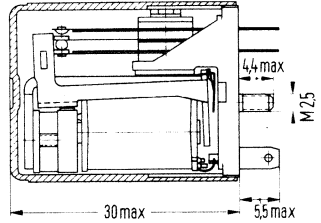
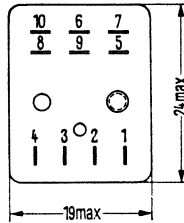

Size II V23003-B★★★

For dc operation, polarized, bistable
Plug-in plus screw fixing

Approx. weight 25 g

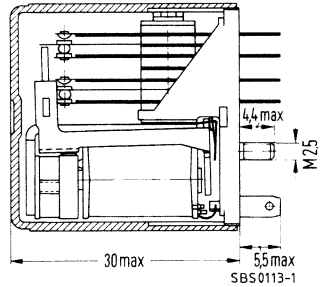
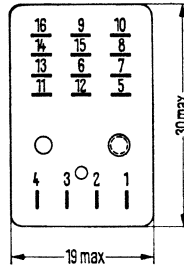

Mounting hole layout
Size I

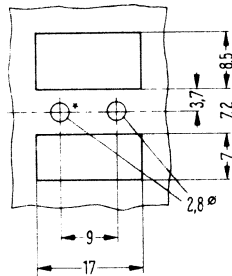

Size II

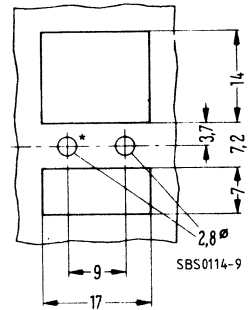

* This hole is omitted if the mounting hole layout is intended for the socket

Ordering code block 3	B1 ..	F1 ..
Contact material	silver, gold-flashed	silver, gold-flashed
Contact ratings:		
Max. switching voltage	150 Vdc/125 Vac	250 V dc/ac
Max. switching current	2 A	5 A
Max. power rating	35 ... 70 W (voltage-dependent) 50 VA	50 ... 140 W (voltage-dependent) 50 VA

Cradle Relays P

Base terminals

Ordering code block 3	B104	B110	F104
Type of contact	single contacts	single contacts	single contacts
Contact arrangement	21-21	21-21-21-21	21-21
Symbols with base connections			
Coil with 2 windings			

Note: OFF position make contact (1) open, break contact (2) closed. If a positive potential is applied to terminal 3 or 4, the relay assumes the OFF position.

Voltage range at 20 °C		Coil resistance at 20 °C ± 10 % Ω	Ordering code	DU						
Wind- ing	Vdc				Pcs					
I	19,5 ... 26,5	400 ¹⁾	A37-B104	5						
II	19,5 ... 25	340								
I	19,5 ... 26,5	400 ¹⁾	B37-B110	5						
II	19,5 ... 25	340								
I	19,5 ... 26,5	400 ¹⁾	B37-F104	5						
II	19,5 ... 25	340								
I	40 ... 49	1400 ¹⁾	B64-B110	5						
II	40 ... 49	1400 ¹⁾								
I	51,5 ... 65	2400 ¹⁾	B44-B110	5						
II	51,5 ... 65	2400 ¹⁾								

1) ± 15 %

Cradle Relays S

Size II

V23054-D★★★

For dc operation, neutral, monostable

Plug-in plus screw fixing

Approx. weight 25 g

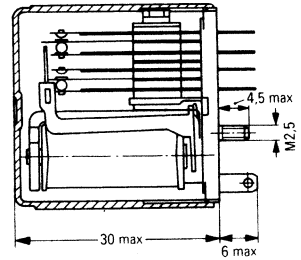
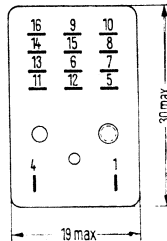

Size III

V23054-E★★★

For dc operation, neutral, monostable

Plug-in plus screw fixing

Approx. weight 30 g

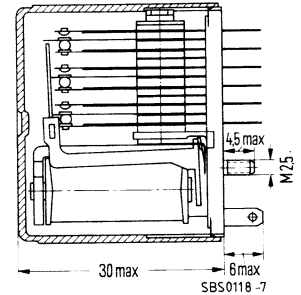
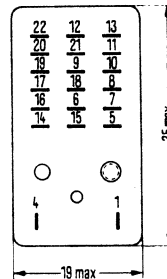

The cradle relay S has a stronger magnet system in comparison with that of cradle relay N, which results in a wider range of operating voltages.

Mounting hole layout
Size II

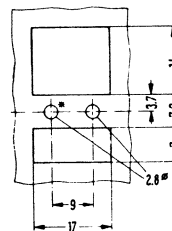

Size III

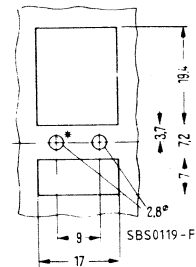

* This hole is omitted if the mounting hole layout is intended for the socket

Ordering code block 3	B1 .. bzw. C1 ..	F1 ..
Contact material	silver, gold-flashed	silver, gold-flashed
Contact ratings:		
Max. switching voltage	150 Vdc/125 Vac	250 Vdc/ac
Max. switching current	2 A	5 A
Max. power rating	35 ... 70 W (voltage-dependent) 50 VA	50 ... 140 W (voltage-dependent) 500 VA

Cradle Relays S

Base terminals

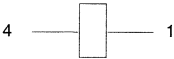
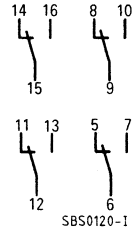
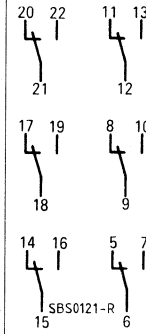
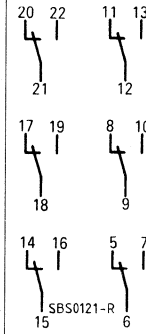
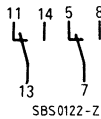
Ordering code block 3	B110	C110	B133	F104
Type of contact	single contacts	bifurcated cont.	single contacts	single contacts
Contact arrangement	21-21-21-21		21-21-21-21-21-21	21-21
Symbols with base connections 				

Voltage range at 20 °C	Coil resistance at 20 °C ± 10 %	Ordering code	DU							
Vdc	Ω	V23054-	Pcs							
Single contacts										
13 ... 39	630	D20-B110	5							
13,5 ... 39	630	D1020-F104	5							
15,5 ... 39	630	E20-B133	5							
29 ... 66	1900 ¹⁾	E22-B133	5							
Bifurcated contacts										
18 ... 39	630	D20-C110	5							

1) ± 15 %

Cradle Relays W

Size I V23005-A★★★

For ac operation,
neutral, monostable
Plug-in plus screw fixing

Approx. weight 35 g

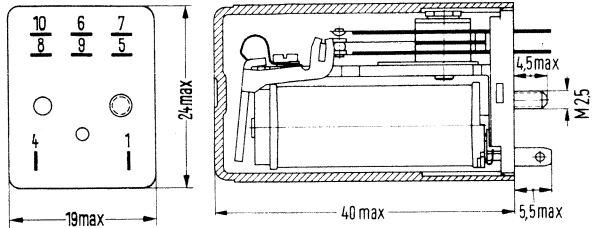

Size II V23005-B★★★

For ac operation,
neutral, monostable
Plug-in plus screw fixing

Approx. weight 40 g

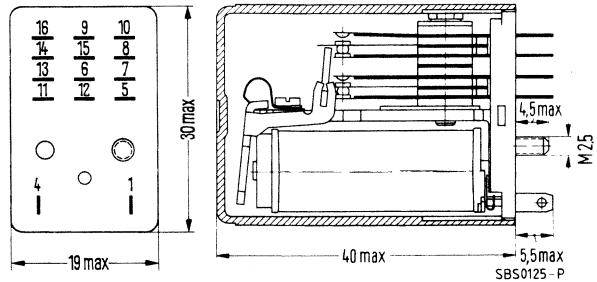

Mounting hole layout Size I

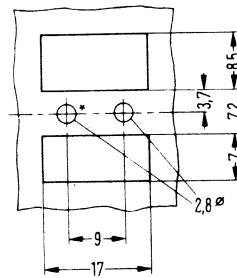

Size II

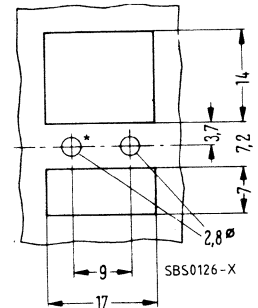

* This hole is omitted if the mounting hole layout is intended for the socket

Cradle Relays W

Base terminals

Ordering code block 3	B104	B110	F104
Type of contact	single contacts	single contacts	single contacts
Contact arrangement	21-21	21-21-21-21	21-21
Symbols with base terminals			

Ordering code block 3	B1 ..	F1 ..
Contact material	silver, gold-flashed	silver, gold-flashed
Contact ratings:		
Max. switching voltage	150 Vdc/125 Vac	250 Vdc/ac
Max. switching current	2 A	5 A
Max. power rating	35 ... 70 W (voltage-dependent) 50 VA	50 ... 140 W (voltage-dependent) 500 VA

Rated voltage	DC coil resistance at 20 °C ± 15 %	Ordering code	DU						
Vdc	Ω	V23005-	Pcs						
220	14000	A4-B104	5						
24	170 ¹⁾	B10-B110	5						
24	170 ¹⁾	B10-F104	5						
220	14000	B4-B110	5						
220	14000	B4-F104	5						

1) ± 10 %

Cradle Relays, Small GP Relays Accessories

Sockets for cradle relays Printed circuit terminals

with hold-down spring for cradle relays N, S and P with hold-down spring for cradle relays W

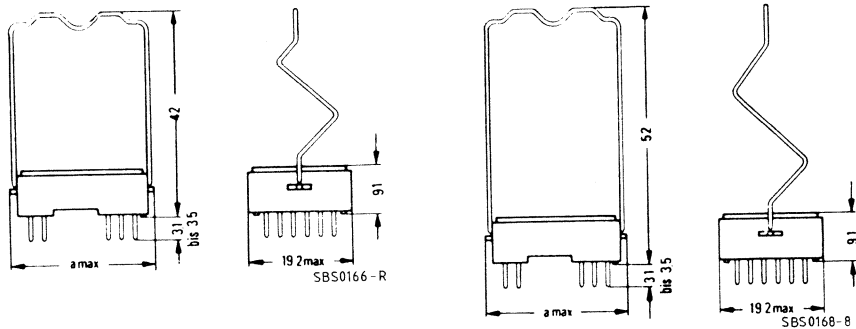

Socket	Size I	Size II	Size III
Width a	26,6	32,5	38

Socket for small general-purpose relay

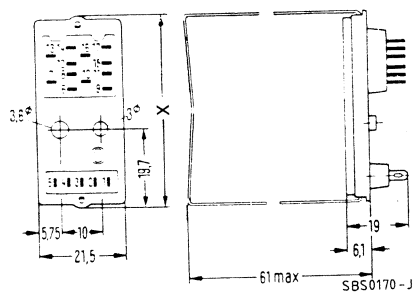

	V23006-G1 ...	V23006-H1 ...
Dimension x	49	62

Relays

Cradle Relays, Small GP Relays Accessories

Article	Ordering code	DU								
		pcs								

Sockets, suitable for

	V23154-								
Cradle relay, size I, PCB terminals	Z1001	20							
Cradle relay, size II, PCB terminals	Z1002	20							
Cradle relay, size III, PCB terminals	Z1028	20							
	V23006-								
Small gen.-purpose relay V23006-G1 ...	Z1001	20							
Small gen.-purpose relay V23006-H1 ...	Z1002	20							

Hold-down springs, suitable for

	V23154-								
Cradle relays N, P, S size I	Z1021	10							
Cradle relays N, P, S size II	Z1022	10							
Cradle relays W size I	Z1023	10							
Cradle relays W size II	Z1024	10							
Cradle relays S size III	Z1034	10							
	V23006-								
Small gen.-purpose relay V23006-G1 ...	Z1003	10							
Small gen.-purpose relay V23006-H1 ...	Z1004	10							

DIP Reed Relays

V23100-V40★★

Reed relay in dual-in line package for dc operation, neutral, monostable, printed circuit terminals, pin arrangement for 2,54 mm grid in acc. with EN 60097 and DIN 40803, fine

Approx. weight 1,5 g

Contact arrangement: 1 make contact

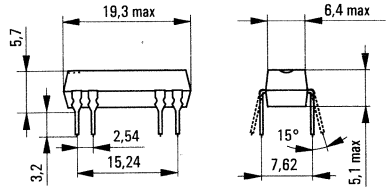

ECR2334-G

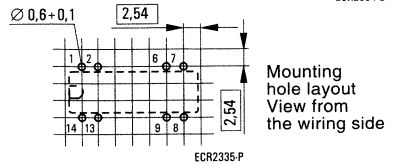

ECR2335-P

Contact ratings:	
Max. switching voltage	180 V
Max. switching current	0,5 A
Max. cont. current	1 A
Max. power rating	10 W/VA

Relay (standard version)	Relay with electrostatic shield	Relay with clamp diode (spark suppression)	Relay with clamp diode (spark suppression) and electrostatic shield
Ordering code, block 3 A	A1	A10	A11

Rated coil voltage	Operating voltage	Max. voltage	Coil resistance at 20°C ± 10%	Ordering code	DU
Vdc	Vdc	Vdc	Ω	V23100-	Pcs
5	≤ 3,5	22	500	V4005-A	25
5	≤ 3,5	22	500	V4005-A1	25
5	≤ 3,5	22	500	V4005-A10	25
5	≤ 3,5	22	500	V4005-A11	25
12	≤ 8,4	33	1000	V4012-A	25
12	≤ 8,4	33	1000	V4012-A1	25
12	≤ 8,4	33	1000	V4012-A10	25
12	≤ 8,4	33	1000	V4012-A11	25
15	≤ 10,5	44	2000	V4015-A	25
15	≤ 10,5	44	2000	V4015-A1	25
15	≤ 10,5	44	2000	V4015-A10	25
15	≤ 10,5	44	2000	V4015-A11	25
24	≤ 16,8	44	2000	V4024-A	25
24	≤ 16,8	44	2000	V4024-A1	25
24	≤ 16,8	44	2000	V4024-A10	25
24	≤ 16,8	44	2000	V4024-A11	25

DIP Reed Relays

V23100-V43★★

Reed relay in dual-in-line package
 For dc operation, neutral, monostable
 Printed circuit terminals
 Pin arrangement for 2,54 mm grid in acc.
 with EN 60097 and DIN 40803, fine

Approx. weight 2 g

Contact arrangement: 2 make contact

Contact ratings:

Max. switching voltage	180 V
Max. switching current	0,5 A
Max. cont. current	1 A
Max. power rating	10 W/VA

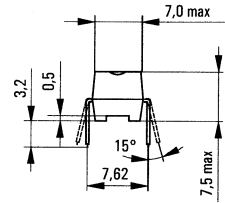
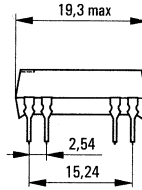

ECR2342.7

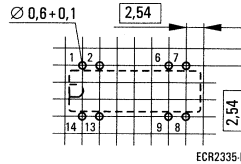

Mounting hole layout
 View
 from the wiring side

Relay (standard version)	Relay with clamp diode (spark suppression)
Ordering code block 3 B	B10
<p>SBS0146-C</p>	<p>SBS0147-K</p>

Rated coil voltage	Operating voltage	Max. voltage	Coil resistance at 20°C ± 10 %	Ordering code	DU						
Vdc	Vdc	Vdc	Ω	V23100-	Pcs						
5	≤ 3,5	14	200	V4305-B	25						
5	≤ 3,5	14	200	V4305-B10	25						
24	≤ 16,8	47	2000	V4324-B	25						
24	≤ 16,8	47	2000	V4324-B10	25						

DIP Reed Relays

V23100-V43★★

Reed relay in dual-in-line package
 For dc operation, neutral, monostable
 Printed circuit terminals
 Pin arrangement for 2,54 mm grid in acc.
 with EN 60097 and DIN 40803, fine
 Approx. weight 2 g

Contact arrangement: 1 changeover contact

Contact ratings:	
Max. switching voltage	175 V
Max. switching current	0,25 A
Max. cont. current	1,2 A
Max. power rating	3 W/VA

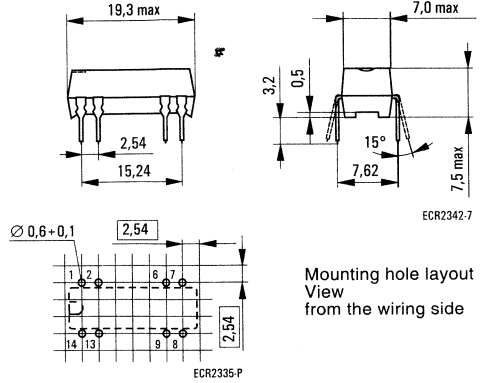

Mounting hole layout
 View
 from the wiring side

Relays

Relay (standard version)	Relay with clamp diode (spark suppression)	Relay with clamp diode (spark suppression) and electrostatic shield
Ordering code block 3 C	C10	C11

Rated coil voltage	Operating voltage	Max. voltage	Coil resistance at 20°C ± 10 %	Ordering code	DU
Vdc	Vdc	Vdc	Ω	V23100-	Pcs
5	≤ 3,5	13	200	V4305-C	25
5	≤ 3,5	13	200	V4305-C10	25
5	≤ 3,5	13	200	V4305-C11	25
12	≤ 8,4	22	500	V4312-C	25
12	≤ 8,4	22	500	V4312-C10	25
24	≤ 16,8	44	2000	V4324-C	25
24	≤ 16,8	44	2000	V4324-C10	25
24	≤ 16,8	44	2000	V4324-C11	25

Reed Relays V6

V23100-V6★★★

For dc operation, neutral and polarized, monostable, printed circuit terminals
 Pin arrangement for 2,5 mm grid in acc. with EN 60097 and DIN 40803, fine
 Approx. weight 15 g

Dot indicates pin rows 1, 3, 5

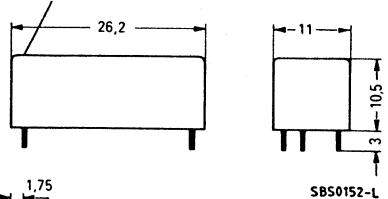

Base terminals

1 make contact

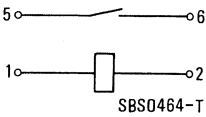

2 make contacts

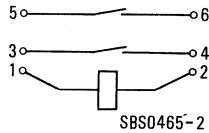

1 make and 1 break contact

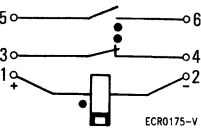

Circuit symbols drawn in OFF position.
 If a positive potential is applied to terminal 1, the relay assumes the ON position.

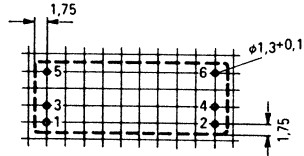

Mounting hole layout
 View from the wiring side

Contact ratings:

Max. switching voltage	100 V
Max. switching current	0,25 A (for break) 0,5 A (for make)
Max. cont. current	0,35 A (for break) 0,75 A (for make)
Max. power rating	10 W

Rated voltage	Voltage range at 20°C	Coil resistance at 20°C ± 10 %	Ordering code	DU						
Vdc	Vdc	Ω	V23100-	Pcs						
1 make contact (neutral, monostable)										
12	8,4 ... 21,6	1100	V6002-A101	10						
24	16,4 ... 42,5	3860 ¹⁾	V6003-A101	10						
2 make contacts (neutral, monostable)										
6	4,5 ... 10,8	430	V6001-A201	10						
12	8,4 ... 21,6	1100	V6002-A201	10						
24	16,4 ... 42,5	3860 ¹⁾	V6003-A201	10						
1 make and 1 break contact (polarized, monostable)										
12	8,4 ... 21,6	1100	V6002-A112	10						
24	16,4 ... 42,5	3860 ¹⁾	V6003-A112	10						

1) ± 15 %

Small General-Purpose Relays

V23006-G★★★

For dc operation, neutral, monostable
 4 single changeover contacts
 With individual solder terminals
 Plug-in plus screw fixing

Approx. weight 90 g

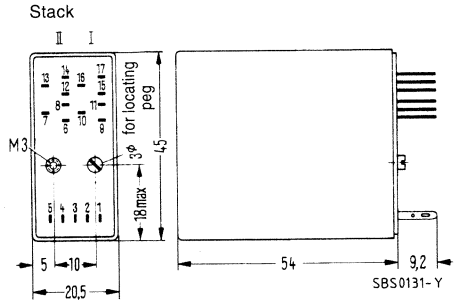

Base terminals

View from the wiring side

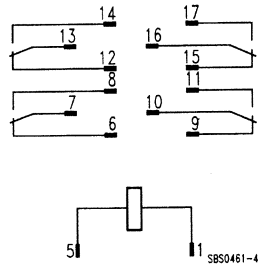

Mounting hole layout

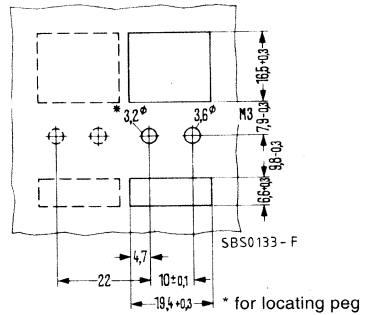

Relays

Contact ratings:

Max. switching voltage 380 Vac/450 Vdc
 Max. switching current 4 A
 Max. power rating
 up to 380 Vac/40 Vdc : 160 W
 up to 60 Vdc : 100 W
 up to 450 Vdc : 60 W

Contact material: silver, gold-flashed

For sockets refer to page 44

Rated voltage	Coil resistance at 20°C ± 10 % Ω	Ordering code	DU						
Vdc		V23006-	Pcs						
24	400	G1016-A34	1						

Small General-Purpose Relays

V23006-H★★★

For dc operation, neutral, monostable
 8 changeover contacts
 With individual solder terminals
 Plug-in plus screw fixing
 Approx. weight 105 g

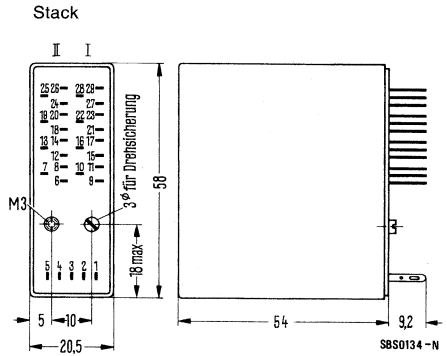

Base terminals

View from the wiring side

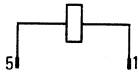
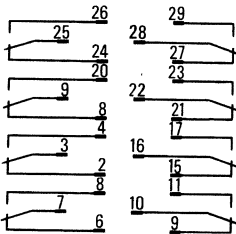

SBS0462-C

Mounting hole layout

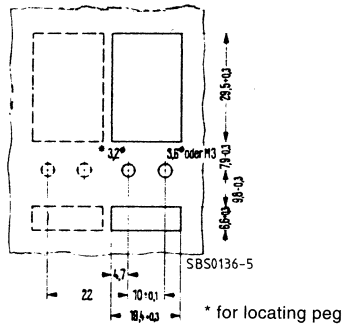

For contact ratings and contact material refer to page 49.

For sockets refer to page 44

Rated voltage	Coil resistance at 20°C ± 10 %	Ordering code	DU										
Vdc	Ω	V23006-	Pcs										
24	220	H1012-A38	1										

Power Relays 15

V23009-A★★★ for dc operation

Neutral, monostable
 2 or 3 changeover contacts
 With quick connects suitable for
 6,3 or 4,8 mm push-on connectors
 in acc. with DIN 46245 or DIN 46247

For screw fixing

Approval: SEV

Approx. weight: with 2 changeover contacts 125 g
 with 3 changeover contacts 140 g

Version with
 2 changeover contacts

3 changeover contacts

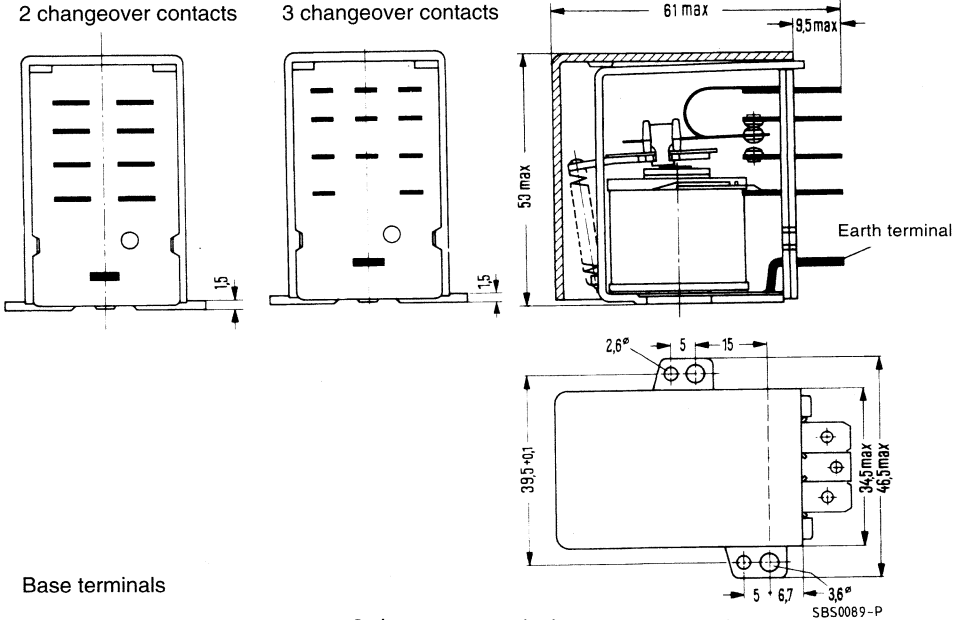

Base terminals

2 changeover contacts

3 changeover contacts

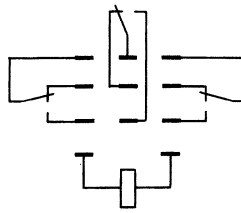
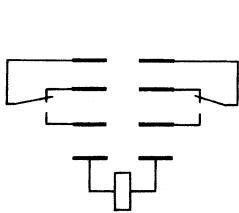

SBS0459-S

SBS0460-V

View from the wiring side

Power Relays 15

Contact material	silver nickel	
Contact arrangement	2 changeover contacts	3 changeover contacts
Contact ratings:		
Max. switching voltage	300 Vdc / 250 Vac	300 Vdc / 250 Vac
Max. switching current ¹⁾	40 A	20 A
Max. continuous current	15 A	8 A
Max. power rating ²⁾	up to 24 Vdc : 360 W 40 Vdc : 140 W 60 Vdc : 80 W 250 Vdc : 100 W 250 Vac : 10 kVA	up to 24 Vdc : 360 W 40 Vdc : 140 W 60 Vdc : 80 W 250 Vdc : 100 W 250 Vac : 5 kVA

Rated voltage	DC coil resistance at 25°C ± 10 % Ω	Ordering code	DU											
		V23009-	Pcs											
2 changeover contacts														
24 Vdc	300	A7-A52	5											
3 changeover contacts														
24 Vdc	300	A7-A101	5											

1) The current of 40 A may flow for a maximum of 4 seconds up to 10 % turn-on time.
 2) The ratings apply to resistive or inductive load with appropriate spark suppression and have been determined with 2 switching cycles/s.

PE PCB Relays

1 pole, 5 A

PE★★★ machine-soldering proof
(immersion cleanable upon request)

For dc operation, neutral, monostable,
with 1 changeover contact

Sensitive coil 200 mW

Low profile (10,0 mm)

Dielectric strength > 4 kV (coil / contact)

Insulation class C/250

Contact material cadmium-free

Approvals: VDE, SEV, UL, CSA

Approx. weight 5 g

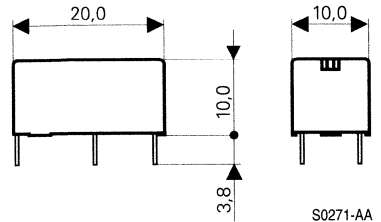

Relays

Base terminals

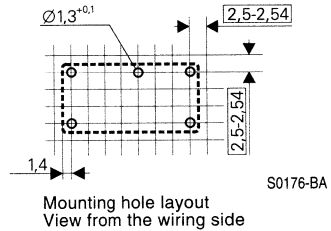
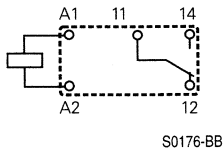

Rated voltage	250 Vac
Max. contact voltage	440 Vac
Rated current	5 A
Nominal power rating	1250 VA

Contact material: AgNi 90/10

	Rated voltage	Voltage range at 20°C	Coil resistance at 20°C	Ordering code	DU				
	Vdc	Vdc	Ω		Pcs				
NEW	5	3,75 ... 12	125 ± 10 %	PE014005	25				
NEW	6	4,5 ... 14,4	172 ± 10 %	PE014006	25				
	12	9,0 ... 28,8	685 ± 10 %	PE014012	25				
	24	18,0 ... 57,6	2725 ± 10 %	PE014024	25				
NEW	48	36,0 ... 115,2	10640 ± 10 %	PE014048	25				

Packing units 25/500 pieces

Slim Power Relays (SNR)

V23092-A1★★★

For dc operation, neutral, monostable, with
 1 changeover contact or 1 make contact
 immersion cleaning
 Printed circuit terminals
 Pin arrangement for 1,25 mm and 1,27 mm

Protection class II in acc.
 with VDE 0631/0700;
 Creepage/clearance ≥ 8 mm;
 Dielectric strength > 4 kV (coil / contact)

Insulation category C/250 nach VDE 0110

Approvals: VDE, UL, CSA

Approximate weight 6 g

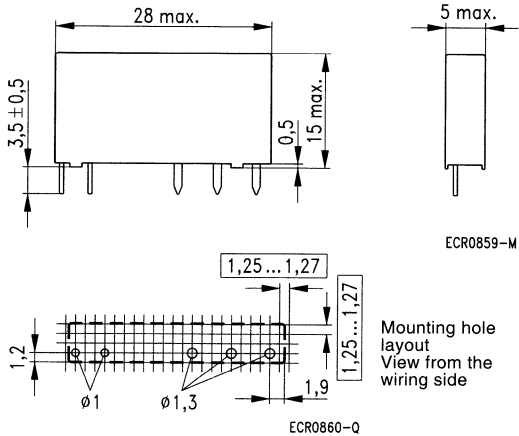

Base terminals

1 changeover contact

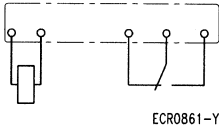

1 make contact

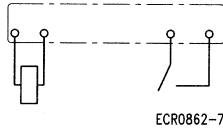

Contact ratings:

Max. switching voltage 300 Vdc/400 Vac

Max. switching current 6 A

Max. continuous current 6 A

Max. power rating 1500 VA

Contact material: silver tin oxide

Rated voltage	Voltage range at 20°C	Coil resistance at 20°C	Ordering code	DU						
Vdc	Vdc	Ω	V23092-	Pcs						
1 changeover contact										
12	9,1 ... 26,8	848 \pm 10 %	A1012-A301	20						
24	18,2 ... 53,7	3390 \pm 10 %	A1024-A301	20						
1 make contact										
12	9,1 ... 26,8	848 \pm 10 %	A1012-A302	20						
24	18,2 ... 53,7	3390 \pm 10 %	A1024-A302	20						

RE PCB Relays

1 pole, 6 A

RE0*** immersion cleanable

For dc operation, neutral, monostable, with 1 make contact, with vent hole

Sensitive coil 200 mW

Low profile (10,6 mm) for efficient rack-mounting PCB assemblies; Creepage/clearance ≥ 4 mm

Insulation category C/250, B/400 in accordance with VDE 0110

Approvals: VDE, ÖVE, SEV, UL, CSA, SEMKO, FINKO

Approximate weight: 5 g

Base terminals

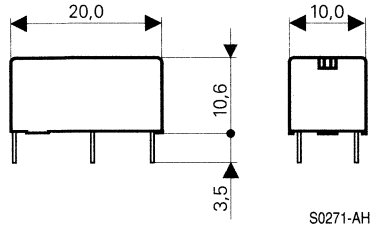

Relays

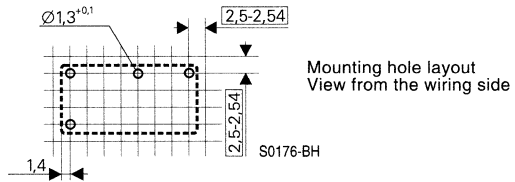
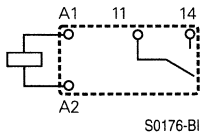

Rated voltage	250 Vac
Max. contact voltage	440 Vac
Rated current	6 A
Make current (max. 4 s at 10 % duty cycle)	15 A
Nominal power rating	1500 VA

Rated voltage Vdc	Voltage range at 20 °C Vdc	Coil resistance at 20 °C Ω	Ordering code	DU	Pcs

Contact material: AgCdO

5	3,5 ... 12,0	125 \pm 10 %	RE030005	25	
6	4,2 ... 14,4	180 \pm 10 %	RE030006	25	
12	8,4 ... 28,8	720 \pm 10 %	RE030012	25	
24	16,8 ... 57,6	2880 \pm 15 %	RE030024	25	
48	33,6 ... 115,2	11520 \pm 15 %	RE030048	25	

Contact material: AgNi 0,15 + htv

12	8,4 ... 28,8	720 \pm 10 %	RE032012	25	
24	16,8 ... 57,6	2880 \pm 15 %	RE032024	25	

Packing units 25/500 pieces

RY II Miniature PCB Relay

1polig, 8 A

RY2★★★ Pinning 3,2 mm, machine-soldering proof

RY5★★★ Pinning 5,0 mm, machine-soldering proof

For dc operation, neutral, monostable, with 1 changeover contact or 1 make contact

Machine-soldering proof
(immersion cleanable upon request)

PCB pin spacing grid 3,2 mm or 5,0 mm

Protection class II in acc. with VDE 0631/0700

Creepage/clearance ≥ 8 mm

Insulation class C/250 in accordance with VDE 0110

Approvals: VDE, ÖVE, SEV, UL, CSA,
NEMKO, DEMKO, FINKO, SEMKO

Approximate weight: 7 g

Base terminal layout

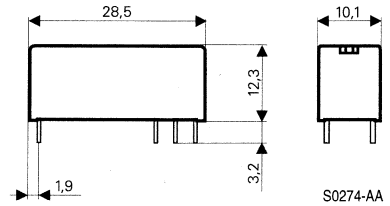

S0274-AA

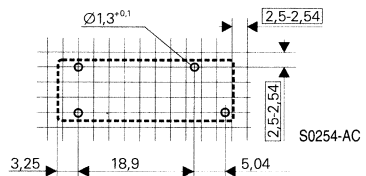
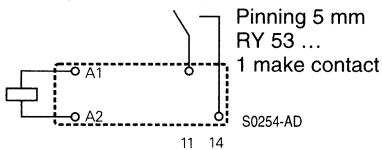
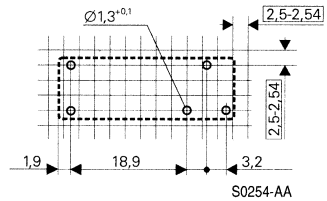
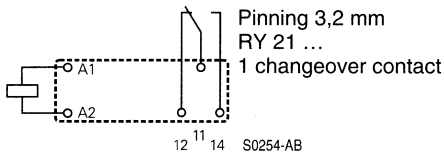

Mounting hole layout
View from the wiring side

Rated voltage	250 Vac
Max. contact voltage	440 Vac
Rated current	8 A
Switching current (in accordance with UL 508)	30 A
Nominal power rating	2000 VA

RY II Miniature PCB Relay

Rated voltage	Voltage range at 20 °C	Coil resistance at 20 °C	Ordering code	DU										
Vdc	Vdc	Ω		Pcs										
1 changeover contact, contact material AgCdO, 3,2 mm pinning														
12	8,4 ... 27,6	620 ± 10 %	RY210012	20										
24	16,8 ... 55,2	2350 ± 10 %	RY210024	20										
1 changeover contact, contact material AgNi 0,15; 3,2 mm pinning														
12	8,4 ... 27,6	620 ± 10 %	RY211012	20										
24	16,8 ... 55,2	2350 ± 10 %	RY211024	20										
1 make contact, contact material AgCdO, 5 mm pinning														
12	8,4 ... 27,6	620 ± 10 %	RY530012	20										
24	16,8 ... 55,2	2350 ± 10 %	RY530024	20										
1 make contact, contact material AgNi 0,15; 5 mm pinning														
12	8,4 ... 27,6	620 ± 10 %	RY531012	20										
24	16,8 ... 55,2	2350 ± 10 %	RY531024	20										

Packing units 20/500 pieces

RY II Miniature PCB Relay Accessories

Sockets with screw terminals

RY78626

snap mounting on DIN rails

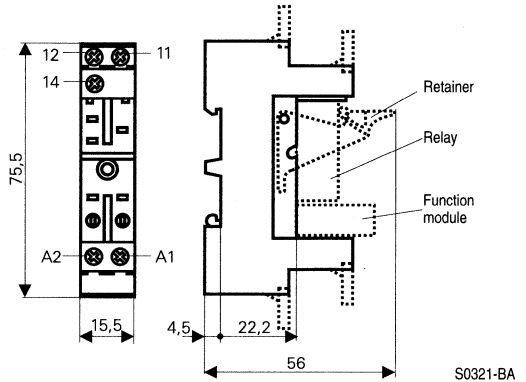

S0321-BA

Sockets with PCB mounting terminals

RY78600

Pinning 3,2 mm

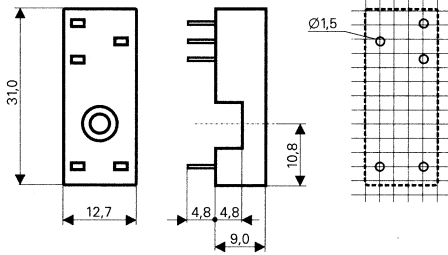

S0322-AA

RY78602

Pinning 5 mm

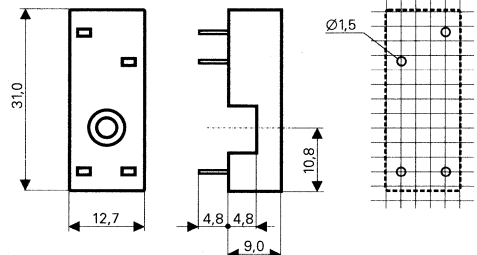

S0322-AB

Accessories	Ordering code	DU				
		Pcs				
Socket with screw terminals, 3,2 mm pinning	RY78626	20				
Diode-, LED- and RC module, marking label	refer to RP II Accessories, page 78					
Retainer/ejector clip for RY78626	RY16046	20				
Socket with PCB mounting terminals, 3,2 mm pinning	RY78600	100				
Socket with PCB mounting terminals, 5 mm pinning	RY78602	100				
Plastic retaining clip for RP78600/02	RY16037	100				

Miniature Power Relays MSR

V23061-★★★

For dc operation, neutral, monostable
 1 changeover or 1 make contact, immersion cleanable
 Printed circuit terminals

Protection class II in accordance with VDE 0631/0700;
 Creepage/clearance ≥ 8 mm;
 Dielectric strength > 4 kV (coil / contact)

Insulation category C/250 in accordance with VDE 0110

Approvals: VDE, UL, CSA, SEV, SEMKO, SETI

Approximate weight 10 g

1 changeover contact

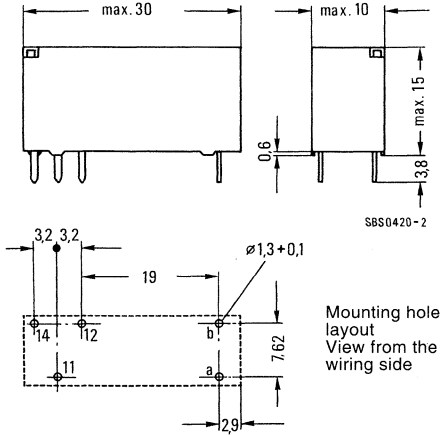

1 make contact

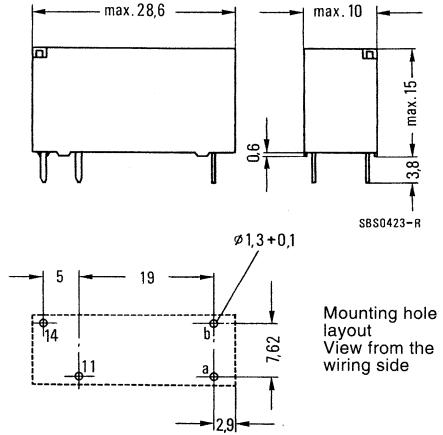

Base terminals

1 changeover contact

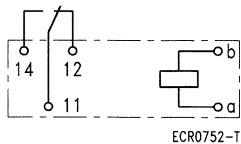

1 make contact

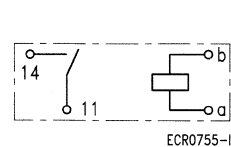

Contact ratings:

Max. switching voltage	300 Vdc/440 Vac (380 Vac in acc. with VDE 0110 Gr. B)
Max. switching current	8/15 A ¹⁾
Max. continuous current max.	8 A ²⁾
Max. power rating	50 ... 220 W (voltage-dependent) 2000 VA

1) The current of 15 A may flow for a maximum of 4 seconds up to 10% on-time.
 2) Operation at maximum continuous current will increase the temperature by approx. 7 °C.

Miniature Power Relays MSR

Rated voltage	Voltage range at 20 °C	Coil resistance at 20 °C	Ordering code	DU									
Vdc	Vdc	Ω	V23061-	Pcs									
1 changeover contact, contact material silver tin oxide													
12	8,5 ... 30	650	B1005-A301	20									
24	17,2 ... 56	2270	B1007-A301	20									
1 changeover contact, contact material silver cadmium oxide													
12	8,5 ... 30	650	B1005-A401	20									
24	17,2 ... 56	2270	B1007-A401	20									
1 changeover contact, contact material fine-grained silver 0,15, gold-flashed													
12	8,5 ... 30	650	B1005-A501	20									
24	17,2 ... 56	2270	B1007-A501	20									
1 make contact, contact material silver tin oxide													
12	8,5 ... 30	650	A1005-A302	20									
24	17,2 ... 56	2270	A1007-A302	20									
1 make contact, contact material silver cadmium oxide													
12	8,5 ... 30	650	A1005-A402	20									
24	17,2 ... 56	2270	A1007-A402	20									
1 make contact, contact material fine-grained silver 0,15, gold-flashed													
12	8,5 ... 30	650	A1005-A502	20									
24	17,2 ... 56	2270	A1007-A502	20									

RT Power PCB Relays

1 pole 10/12/16 A, 2pole 8 A

RT1★★★ 1polig 10/12 A, pinning 3,5 mm

RT3★★★ 1polig 16 A, pinning 5,0 mm

RT4★★★ 2polig 8 A, pinning 5,0 mm

RTE★★★ 2polig 8 A, pinning 5,0 mm;
immersion-cleanable

For dc or ac operation, neutral, monostable

Machine-soldering proof (RT1, RT3 and RT4)
or immersion-cleanable (RTE)

PCB pin spacing grid 3,5 bzw. 5,0 mm

Standard or sensitive version
with 1 changeover contact, 1 make contact or
2 changeover contacts; Creepage/clearance ≥ 10 mm

Protection class II in acc. with VDE 0631/0700;
Dielectric strength > 5 kV (coil / contact);
cadmium-free contacts

For electrical control and switching technology, e.g. for heating controllers,
switching contactors, servo-motor controls, solenoid valves etc.

Approvals: VDE, ÖVE, SEV, UL, CSA, BEAB

Approximate weight: 12 g

Base terminals

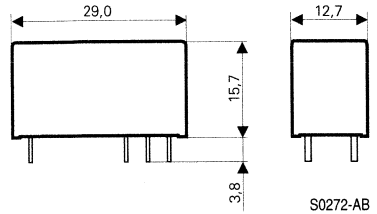

Relays

1 pole 10/12 A

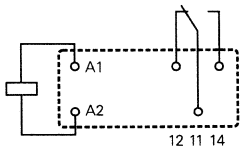

Pinning 3,5 mm

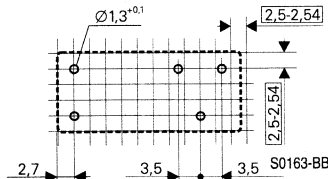

Pinning 5 mm

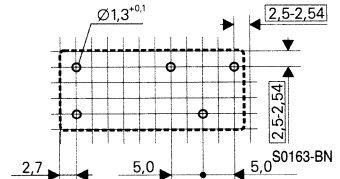

1 pole 16 A

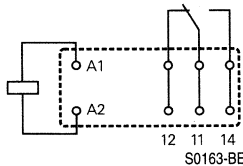

Mounting hole layout View from the wiring side

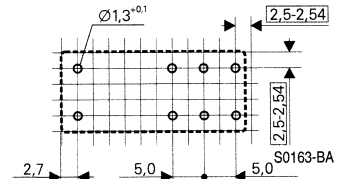

2pole 8 A

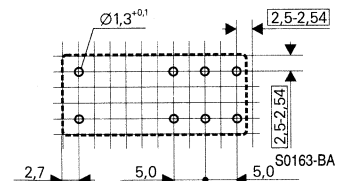
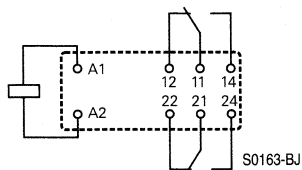

RT Power PCB Relays

Rated voltage	250 Vac	
Max. contact voltage	440 Vac	
Rated current	1pol. 12/16 A	2pol. 8 A
Make current (max. 4 s at 10 % duty cycle)	20/25 A	14 A
Nominal power rating	3000/4000 VA	2000 VA

Contact material: AgNi 90/10

Rated voltage Vdc	Voltage range at 20°C Vdc	Coil resistance at 20°C Ω	Ordering code	DU	Pcs										
-------------------	---------------------------	---------------------------	---------------	----	-----	--	--	--	--	--	--	--	--	--	--

DC operating voltage

1 pole, 12 A, pinning 3,5 mm, 1 changeover contact

12	8,4 ... 27,6	360 ± 10 %	RT114012	20											
24	16,8 ... 55,2	1440 ± 10 %	RT114024	20											

1 pole, 16 A, pinning 5 mm, 1 changeover contact

12	8,4 ... 27,6	360 ± 10 %	RT314012	20											
24	16,8 ... 55,2	1440 ± 10 %	RT314024	20											
NEW 48	33,6 ... 110,4	5760 ± 15 %	RT314048	100											

1 pole, 16 A, pinning 5 mm, 1 make contact

12	8,4 ... 27,6	360 ± 10 %	RT334012	20											
24	16,8 ... 55,2	1440 ± 10 %	RT334024	20											

2 pole, 8 A, pinning 5 mm, 2 changeover contacts

12	8,4 ... 27,6	360 ± 10 %	RT424012	20											
24	16,8 ... 55,2	1440 ± 10 %	RT424024	20											
48	33,6 ... 110,4	5760 ± 15 %	RT424048	20											

2pole, 8 A, pinning 5 mm, 2 changeover contacts; immersion-cleanable

NEW 12	8,4 ... 27,6	360 ± 10 %	RTE24012	100											
NEW 24	16,8 ... 55,2	1440 ± 10 %	RTE24024	100											

DC operating voltage

Sensitive, 1 pole, 10 A, pinning 3,5 mm, 1 changeover contact

12	9,0 ... 34,2	576 ± 10 %	RT174012	20											
24	18,0 ... 68,4	2304 ± 11 %	RT174024	20											

Packing units 20/500 pieces

RT Power PCB Relays

Rated voltage	Voltage range at 20°C	Coil resistance at 20°C	Ordering code	DU						
Vac	Vac	Ω		Pcs						

AC operating voltage
1 pole, 12 A, pinning 3,5 mm, 1 changeover contact

24	0,9 ... 1,1 × U _N	350 ± 10 %	RT114524	20						
115	0,9 ... 1,1 × U _N	8100 ± 10 %	RT114615	20						
230	0,9 ... 1,1 × U _N	32500 ± 10 %	RT114730	20						

1 pole, 16 A, pinning 5 mm, 1 changeover contact

24	0,9 ... 1,1 × U _N	350 ± 10 %	RT314524	20						
115	0,9 ... 1,1 × U _N	8100 ± 10 %	RT314615	20						
230	0,9 ... 1,1 × U _N	32500 ± 10 %	RT314730	20						

2 pole, 8 A, pinning 5 mm, 2 changeover contacts

24	0,9 ... 1,1 × U _N	350 ± 10 %	RT424524	20						
115	0,9 ... 1,1 × U _N	8100 ± 10 %	RT424615	20						
230	0,9 ... 1,1 × U _N	32500 ± 10 %	RT424730	20						

Packing units 20/500 pieces

RT Power PCB Relays, bistable

1pole 16 A, 2pole 8 A

RT3★★★ 1pole 16 A, pinning 5,0 mm
RT4★★★ 2pole 8 A, pinning 5,0 mm

For dc operation, polarized,
 bistable, with 1 or 2 windings

Machine-soldering proof

PCB pin spacing grid 5,0 mm

With 1 or 2 changeover contacts;
 with creepage/clearance ≥ 10 mm

Protection class II in acc. with VDE 0631/0700;
 Dielectric strength > 5 kV (coil / contact);
 cadmium-free contacts

For electrical control and switching technology,
 e.g. for heating controllers, switching contactors,
 servo-motor controls, solenoid valves etc.

Approvals: RT3: VDE, UL applied for
 RT4: VDE, UL, CSA, BEAB, SEV, ÖVE

Approximate weight: 12 g

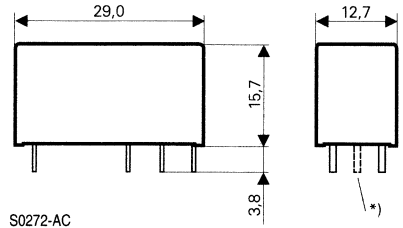

S0272-AC

Base terminals

2pole 8 A

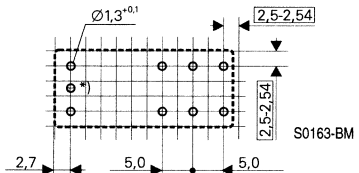
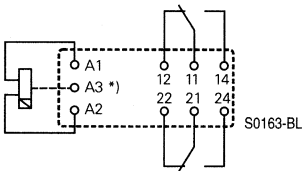

Mounting hole layout
 View from
 the wiring side

1pole 16 A

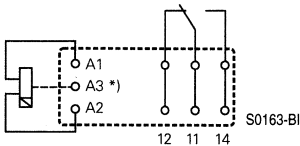

*) just at 2 windings

RT Power PCB Relays, bistable

Rated voltage	250 Vac	
Max. contact voltage	440 Vac	
Rated current	1pol. 16 A	2pol. 8 A
Make current (max. 4 s at 10 % duty cycle)	25 A	14 A
Nominal power rating	4000 VA	2000 VA

Contact material: AgNi 90/10

Rated voltage Vdc	Voltage range at 20°C SET/RESET Vdc	Coil resistance at 20°C Ω	Ordering code	DU Pcs										
----------------------	---	------------------------------	---------------	-----------	--	--	--	--	--	--	--	--	--	--

with 1 winding, bistable, 400 mW nominal power
1 pole, 16 A, 1 changeover contact

12	8,4 ... 14,4 6,6 ... 14,4	360 ± 10 %	RT314A12	20										
24	16,8 ... 28,8 13,2 ... 28,8	1440 ± 10 %	RT314A24	20										

with 1 winding, bistable, 400 mW nominal power
2 pole, 8 A, 2 changeover contacts

12	8,4 ... 14,4 6,6 ... 14,4	360 ± 10 %	RT424A12	20										
24	16,8 ... 28,8 13,2 ... 28,8	1440 ± 10 %	RT424A24	20										

with 2 windings (I and II, with equal technical data), bistable, each 600 mW nominal power
1 pole, 16 A, 1 changeover contact

12	8,4 ... 18 6,6 ... 18	240 ± 10 %	RT314F12	20										
24	16,8 ... 36 13,2 ... 36	886 ± 10 %	RT314F24	20										

with 2 windings (I and II, with equal technical data), bistable, each 600 mW nominal power
2 pole, 8 A, 2 changeover contacts

12	8,4 ... 18 6,6 ... 18	240 ± 10 %	RT424F12	20										
24	16,8 ... 36 13,2 ... 36	886 ± 10 %	RT424F24	20										

Packing units 20 or 25/500 pieces

RT Power PCB Relays, 105 °C

1 pole 10 A

RTH★★★ 1pole 10 A, pinning 5,0 mm

For dc operation, neutral, monostable

Machine-soldering proof

PCB pin spacing grid 5,0 mm

Sensitive version with 1 make contact;
creepage/clearance ≥ 10 mm

Protection class II in acc. with VDE 0631/0700;
Dielectric strength > 5 kV (coil / contact);
Cadmium-free contacts

For use at high ambient temperatures

Approval: VDE applied for

Approximate weight: 12 g

Base terminals

1pole 10 A

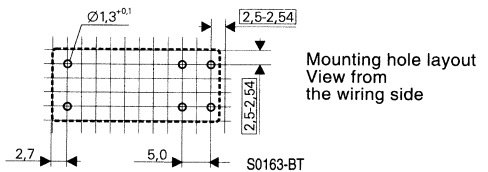
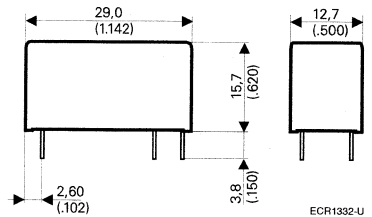
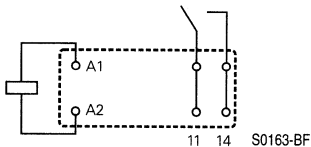

Rated voltage	250 Vac
Max. contact voltage	440 Vac
Rated current	10 A
Make current (max. 4 s at 10 % duty cycle)	20 A
Nominal power rating	2500 VA

Contact material: AgNi 90/10

Rated voltage	Voltage range at 20 °C	Coil resistance at 20 °C	Ordering code	DU					
Vdc	Vdc	Ω		Pcs					

Sensitive, 1 pole, 10 A, 1 make contact

12	9,0 ... 34,2	576 \pm 10 %	RTH84012	20					
24	18,0 ... 68,4	2304 \pm 11 %	RTH84024	20					

Packing units 20/500 pieces

1pole 16 A

RT33K★★ 1pole 16 A, pinning 5,0 mm

For dc operation,
neutral, monostable

machine-soldering proof

PCB pin spacing grid 5,0 mm

with 1 make contact;

with creepage/clearance ≥ 10 mm

Protection class II in acc. with VDE 0631/0700;

Dielectric strength > 5 kV (coil / contact);

cadmium-free contacts

Approvals: VDE; UL applied for

Approximate weight 12 g

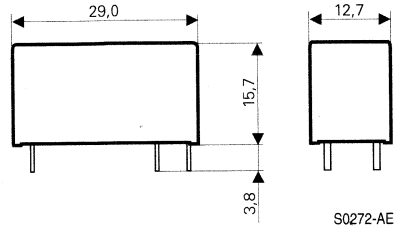

Base terminals

1pole 16 A

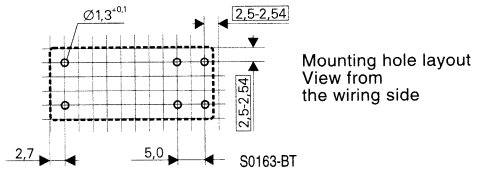
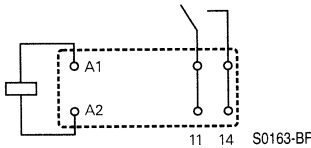

Rated voltage	250 Vac
Max. contact voltage	440 Vac
Rated current	16 A
Inrush peak current (20 ms)	80 A
Nominal power rating	4000 VA

Contact material: AgNi 90/10

Rated voltage	Voltage range at 20°C	Coil resistance at 20°C	Ordering code	DU							
Vdc	Vdc	Ω		Pcs							
High Inrush, 1pole, 16 A, pinning 5,0 mm, 1 make contact											
12	8,4 ... 27,6	360 \pm 10 %	RT33K012	20							
24	16,8 ... 55,2	1440 \pm 10 %	RT33K024	20							

Packing units 20/500 pieces

RT Power PCB Relays Accessories

Sockets with screw terminals RT78624 and RT78625

snap mounting
on DIN rail

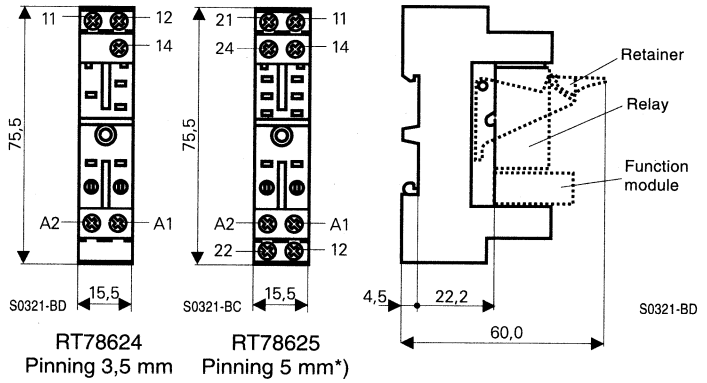

*) For 1 pole relays (12 A):
Relay terminals 11 – 12 – 14
are connected to socket
terminals 21 – 12 – 14

RT78626

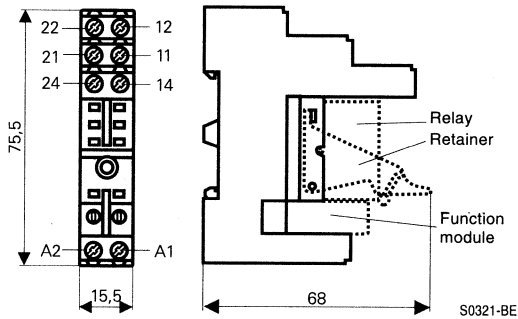

Sockets with PCB mounting terminals RP78601

Pinning 3,5 mm

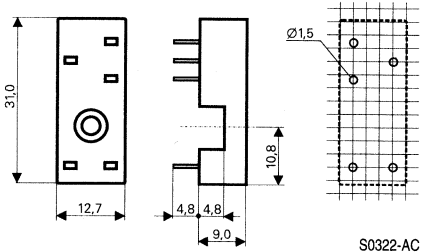

RP78602

Pinning 5 mm

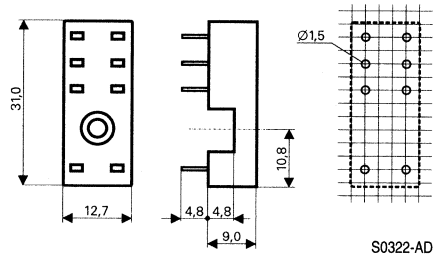

RT Power PCB Relays Accessories

Accessories	Ordering code	DU								
		Pcs								
Socket with screw terminals, 3,5 mm pinning, for 1 pole relay	RT78624	20								
Socket with screw terminals, 5 mm pinning, for 1 pole relay 16 A and 2 pole relay	RT78625	20								
I/O-Socket with screw terminals, 5 mm pinning, for 1 pole and 2 pole relay	RT78626	20								
Diode-, LED- and RC module, marking label	refer to RP II Accessories, page 78									
Retainer/ejector clip for RT78624/25/26	RT16016	20								
Socket with PCB mounting terminals, 3,5 mm pinning, for 1 pole relay	RP78601	100								
Socket with PCB mounting terminals, 5 mm pinning, for 1 pole and 2 pole relay	RP78602	100								
Plastic retaining clip for RP78601/02	RY16041	100								
Metal retaining clip for RP78601/02	RT28516	100								

RP II/1 PCB Relays

1pole, 8/12/16 A

- RP3**★★★ 16 A, machine-soldering proof
- RP4**★★★ 8/12 A, machine-soldering proof
- RP7**★★★ 16 A, immersion cleanable
- RP8**★★★ 12 A, immersion cleanable

For dc operation, neutral, monostable, with 1 changeover contact or 1 make contact

Machine-soldering proof or immersion cleanable

PCB pin spacing grid 3,5 or 5,0 mm

Protection class II in acc. with VDE 0631/0700;
 Creepage/clearance ≥ 8 mm;
 Dielectric strength > 4 kV (coil / contact)

For electrical control and switching technology, e.g. for heating controllers, switching contactors, servo-motor controls solenoid valves etc.

Approvals: VDE, ÖVE, SEV, UL, CSA, NEMKO

Approximate weight 18 g

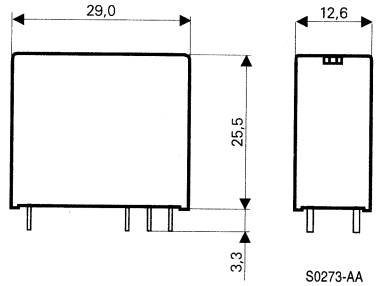

Pinning 3,5 mm

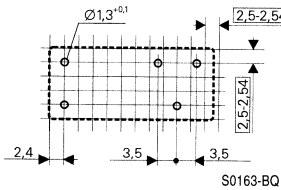

8 A and 12 A version

Pinning 5 mm

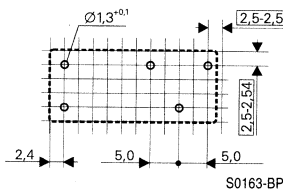

12 A version

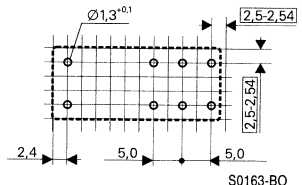

16 A version

Base terminals

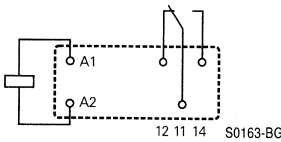

8 A and 12 A version

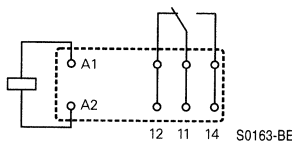

16 A version

Mounting hole layout View from the wiring side

Rated voltage	250 Vac
Max. contact voltage	440 Vac
Rated current	8/12/16 A
Make current (max. 4 s at 10 % duty cycle)	16/20/25 A
Nominal power rating	2000/3000/4000 VA

For accessories, refer to page 78

RP II/1 PCB Relays

Rated voltage	Voltage range at 20°C	Coil resistance at 20°C	Ordering code	DU																
Vdc	Vdc	Ω		Pcs																
machine-soldering proof, 1 changeover contact, contact material AgCdO, 16 A; pinning 5,0 mm																				
12	8,4 ... 21,6	270 ± 10 %	RP310012	20																
24	16,8 ... 43,2	1100 ± 15 %	RP310024	20																
48	33,6 ... 86,4	4400 ± 15 %	RP310048	20																
machine-soldering proof, 1 make contact, contact material AgCdO, 16 A; pinning 5,0 mm																				
12	8,4 ... 21,6	270 ± 10 %	RP330012	20																
24	16,8 ... 43,2	1100 ± 15 %	RP330024	20																
machine-soldering proof, 1 changeover contact, contact material AgNi 0,15 + hv, 8 A; 3,5 mm pinning																				
12	8,4 ... 21,6	270 ± 10 %	RP412012	20																
24	16,8 ... 43,2	1100 ± 15 %	RP412024	20																
machine-soldering proof, 1 changeover contact, contact material AgCdO, 12 A; 3,5 mm pinning																				
12	8,4 ... 21,6	270 ± 10 %	RP418012	20																
24	16,8 ... 43,2	1100 ± 15 %	RP418024	20																
immersion cleanable, 1 changeover contact, contact material AgCdO, 16 A; 5,0 mm pinning																				
12	8,4 ... 21,6	270 ± 10 %	RP710012	20																
24	16,8 ... 43,2	1100 ± 15 %	RP710024	20																
immersion cleanable, 1 changeover contact, contact material AgCdO, 12 A; 3,5 mm pinning																				
12	8,4 ... 21,6	270 ± 10 %	RP818012	20																
24	16,8 ... 43,2	1100 ± 15 %	RP818024	20																

Packing units 20/500 pieces

RP 3 SL PCB Relays – “Special load”

1pole, 16 A

RP3SL★★★ machine-soldering proof
(immersion cleanable upon request)

For dc operation, neutral, monostable
with 1 make contact

PCB pin spacing grid 5,0 mm

Protection class II in acc. with VDE 0631/0700;
Creepage/clearance ≥ 8 mm;
Dielectric strength > 4 kV (coil / contact)

For switching incandescent lamps,
quartz-iodine lamps, capacitive loads;
Contact clearance $> 0,6$ mm;
for high inrush currents 120 A/20 ms

Approvals: VDE, ÖVE, SEV, UL

Approximate weight: 17 g

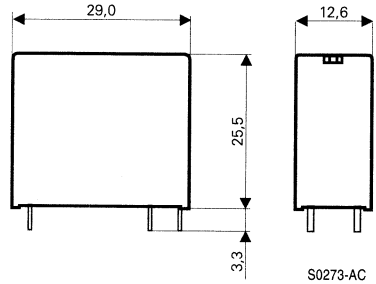

Base terminals

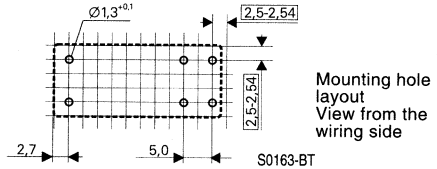
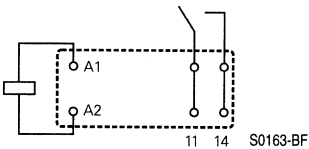

Rated voltage	250 Vac
Max. contact voltage	440 Vac
Rated current	16 A
Rated current / inrush peak current	20/120 A
Nominal power rating	4000 VA

Contact material: AgSnO

Rated voltage	Voltage range at 20°C	Coil resistance at 20°C	Ordering code	DU					
Vdc	Vdc	Ω		Pcs					
12	8,6 ... 24,0	270 \pm 10 %	RP3SL012	20					
24	17,3 ... 48,0	1100 \pm 15 %	RP3SL024	20					

Packing units 20/500 pieces

Miniature Power Relays IF

V23077-A★★★

For dc operation, neutral, monostable
 1 make or 1 break contact
 Dust-protected
 Printed circuit terminals (input and output) and quick connects for 6,35 mm push-on connectors (output)
 Pin arrangement for 2,5 mm grid in acc. with EN 60097 and DIN 40 803, fine
 Version with 3 mm contact clearance upon request

Approvals: VDE, SEV, UL, CSA, BEAB, SEMKO, ÖVE

Approx. weight 26 g

Note:

The creepage distances and clearances prescribed by VDE 0435 must not be affected by printed conductors routed in between relay and PC board.

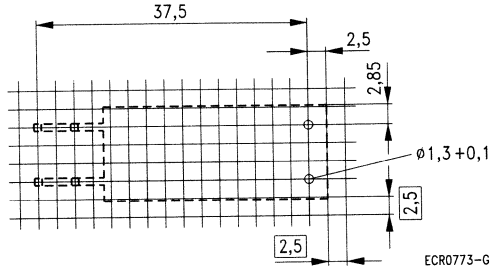
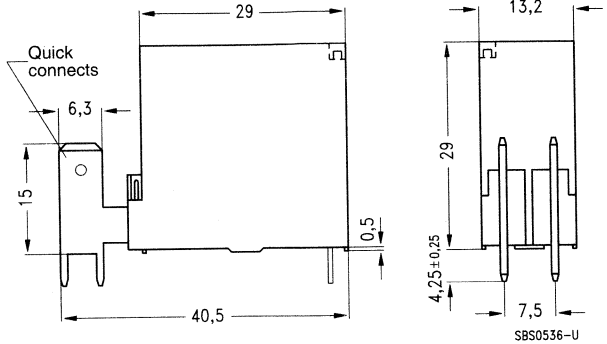

Mounting hole layout
View from the wiring side

Relays

Base terminals

1 make contact

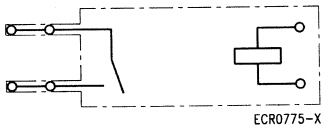

1 break contact

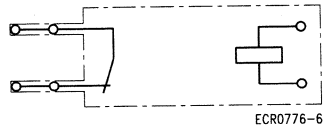

Contact ratings:

Max. switching voltage	300 Vdc/440 Vac
Max. switching current	25 A ¹⁾
Max. continuous current	16 A
Max. power rating	500 W / 4000 VA
Contact material	Silver cadmium oxide

1) The current of 4 A may flow for a maximum of 4 seconds up to 10 % relative on-time.

Miniature Power Relays IF

Rated voltage Vdc	Voltage range at 20°C Vdc	Coil resistance at 20°C ± 10 % Ω	Ordering code V23077-	DU Pcs										
1 make contact														
12	8,4 ... 33,8	400	A1005-A402	20										
24	16,8 ... 67,7	1600	A1007-A402	20										
1 break contact														
12	8,4 ... 33,8	400	A1005-A403	20										
24	16,8 ... 67,7	1600	A1007-A403	20										

RP II/2 PCB Relays

2pole, 8 A

RP4★★★ machine-soldering proof

RP8★★★ immersion cleaning

For dc operation, neutral, monostable,
with 2 changeover contacts

PCB pin spacing grid 5,0 mm

Creepage/clearance ≥ 8 mm;

Dielectric strength > 4 kV (coil / contact)

Für electrical control and
switching equipment.

Approvals: VDE, ÖVE, SEV, UL, CSA,
NEMKO, DEMKO, FINKO, KEMA

Approximate weight: 18 g

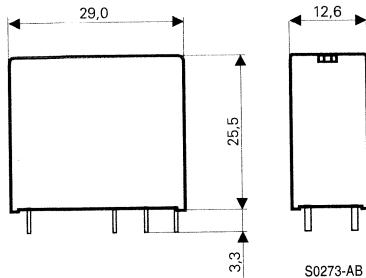

Relays

Base terminals

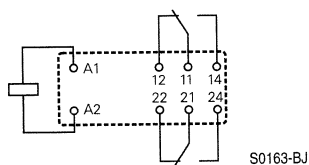

S0163-BJ

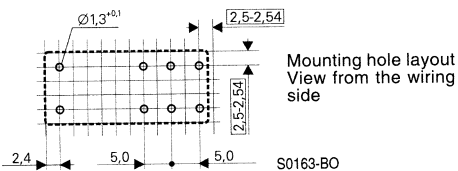

Mounting hole layout
View from the wiring
side

S0163-BO

Rated voltage	250 Vac
Max. contact voltage	440 Vac
Rated current	2 × 8 A
Make current (max. 4 s at 10 % duty cycle)	14 A
Nominal power rating	2000 VA

RP II/2 PCB Relays

Rated voltage	Voltage range at 20 °C	Coil resistance at 20 °C	Ordering code	DU									
Vdc	Vdc	Ω		Pcs									
machine-soldering proof, contact material AgCdO													
12	8,4 ... 21,6	270 ± 10 %	RP420012	20									
24	16,8 ... 43,2	1100 ± 15 %	RP420024	20									
48	33,6 ... 91,2	4400 ± 15 %	RP420048	20									
machine-soldering proof, contact material AgNi 0,15 + hv													
12	8,4 ... 21,6	270 ± 10 %	RP421012	20									
24	16,8 ... 43,2	1100 ± 15 %	RP421024	20									
immersion-cleanable, contact material AgCdO													
12	8,4 ... 21,6	270 ± 10 %	RP820012	20									
24	16,8 ... 43,2	1100 ± 15 %	RP820024	20									
immersion-cleanable, contact material AgNi 0,15 + hv													
12	8,4 ... 21,6	270 ± 10 %	RP821012	20									
24	16,8 ... 43,2	1100 ± 15 %	RP821024	20									

Packing units 20/500 pieces

Sockets with screw terminals
RT78624 and RT78625

snap mounting
on DIN rail

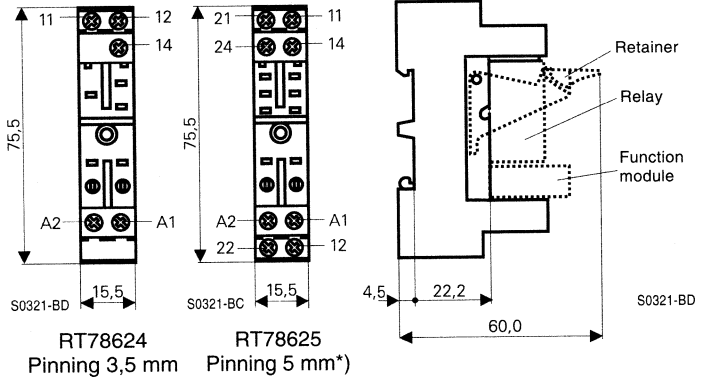

*) For 1 pole relays (8/12 A):
Relay terminals 11 - 12 - 14
are connected to socket
terminals 21 - 12 - 14

RT78626

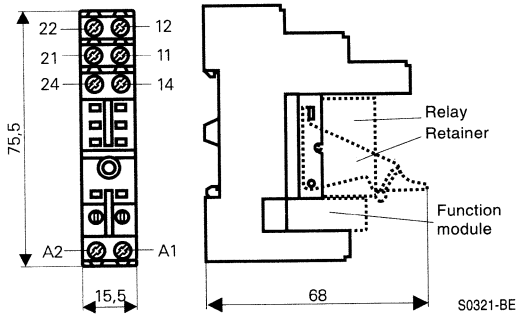

Sockets with PCB mounting terminals
RP78601

Pinning 3,5 mm

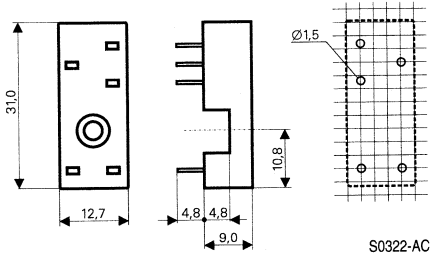

RP78602

Pinning 5 mm

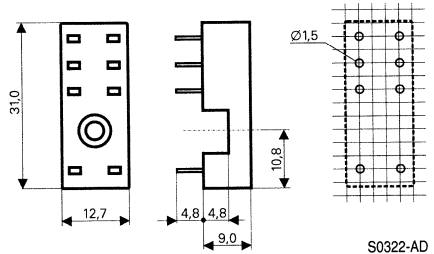

RP II/2 PCB Relays Accessories

Accessories	Ordering code	DU								
		Pcs								
Socket with screw terminals, 3,5 mm pinning, for 1 pole relay	RT78624	20								
Socket with screw terminals, 5 mm pinning, for 1 pole relay 16 A and 2 pole relay	RT78625	20								
I/O-Socket with screw terminals, 5 mm pinning, for 1 pole and 2 pole relay	RT78626	20								
Marking plate, white, for sockets RT78624/25/26	RY16040	20								
Retainer/ejector clip for RT78624/25/26	RP16104	20								
Diode module (1 N 4007)	RPMT00A0	20								
LED module 24 VDC with recovery diode	RPML0024	20								
LED module 110 VDC	RPML0110	20								
LED module 12/24 VDC/AC	RPML0524	20								
LED module 110/230 VAC	RPML0730	20								
RC module 24/48 VAC	RPMU0548	20								
RC module 110/230 VAC	RPMU0730	20								
Socket with PCB mounting terminals, 3,5 mm pinning, for 1 pole relay	RP78601	100								
Socket with PCB mounting terminals, 5 mm pinning, for 1 pole and 2 pole relay	RP78602	100								
Plastic retaining clip for RP78601/02	RP16100	100								
Metal retaining clip for RP78601/02	RP28500	100								

Card Relays E

V23057-A★★★, horizontal

For dc operation, neutral,
 monostable
 1 changeover contact, single contacts
 Immersion cleanable
 Printed circuit terminals
 Pin arrangement for 2,5 mm
 and 2,54 mm grid in acc. with
 DIN 60097 and DIN 40803, fine
 Approvals: VDE, SEV, CSA, UL
 Approx. weight 20 g

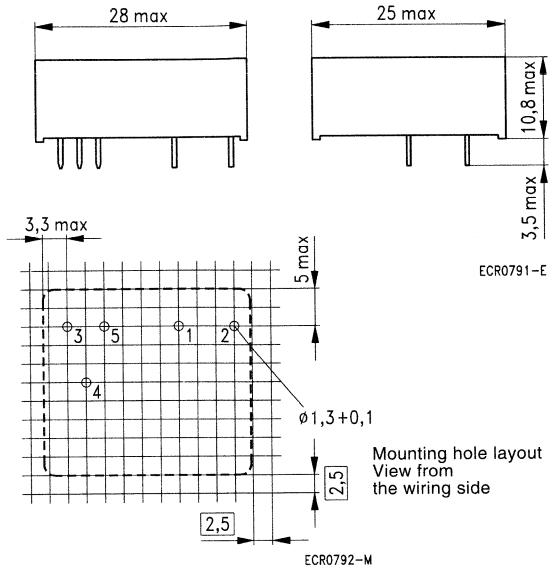

Relays

Base terminals

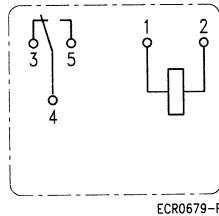

Card Relays E

V23057-B★★★, upright

For dc operation, neutral, monostable
 1 changeover, single contacts
 Immersion cleanable
 Printed circuit terminals

Pin arrangement for 2,5 mm and
 2,54 mm grid in acc. with
 EN 60097 and DIN 40803, fine

Approvals: VDE, SEV, CSA, UL

Approx. weight 20 g

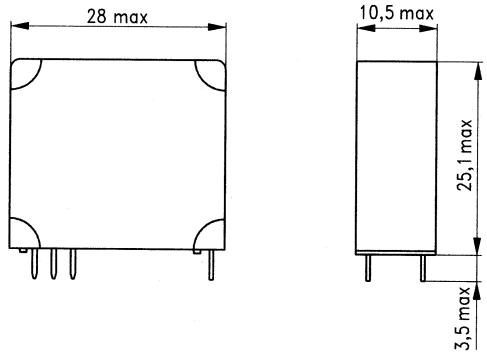

ECR0789-3

Base terminals

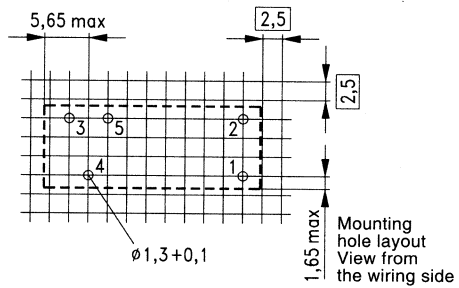
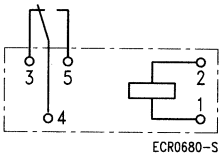

ECR0790-6

Card Relays E

Ordering code block 3		A101	A201	A401
Contact material		fine- grained silver, goldflashed	silver nickel	silver cadmium oxide
Max. switching voltage	V	300-440 ~		
Max. switching current	A	5/15 ¹⁾	8/15 ¹⁾	
Max. power rating DC voltage	W W W W	50 ... 330 (voltage-dependent)	up to 24 V: 1 00 30 V: 80 200 V: 30 250 V: 50	35 ... 330 (voltage-dependent)
AC voltage	VA	1250	2000	
Max. continuous current	A	8		

Rated voltage	Voltage range at 20 °C	Coil resistance at 20 °C ± 15 %	Ordering code	DU						
Vdc	Vdc	Ω	V23057-	Pcs						

horizontal version

Rated voltage	Voltage range at 20 °C	Coil resistance at 20 °C ± 15 %	Ordering code	DU						
12	8,3 ... 21,5	330	A2-A101	20						
12	8,3 ... 21,5	330	A2-A201	20						
12	8,3 ... 21,5	330	A2-A401	20						
24	16,8 ... 40	1200 ²⁾	A6-A101	20						
24	16,8 ... 40	1200 ²⁾	A6-A201	20						
24	16,8 ... 40	1200 ²⁾	A6-A401	20						
48	32,8 ... 79	4700 ²⁾	A13-A101	20						

upright version

Rated voltage	Voltage range at 20 °C	Coil resistance at 20 °C ± 15 %	Ordering code	DU						
6	4,2 ... 10,6	80	B1-A101	20						
12	8,3 ... 21,5	330	B2-A101	20						
12	8,3 ... 21,5	330	B2-A201	20						
12	8,3 ... 21,5	330	B2-A401	20						
24	16,8 ... 40	1200 ²⁾	B6-A101	20						
24	16,8 ... 40	1200 ²⁾	B6-A201	20						
24	16,8 ... 40	1200 ²⁾	B6-A401	20						
48	33,6 ... 79	4700 ²⁾	B13-A101	20						
48	33,6 ... 79	4700 ²⁾	B13-A401	20						
60	42 ... 98	7200 ²⁾	B23-A101	20						

1) The current of 15 A may flow for a maximum of 4 seconds up to 10 % on-time.
 2) ± 15 %

Miniature Power Relays U

V23148-A★★★

For dc operation, neutral, monostable,
 1 changeover, 1 make or 1 break contact
 Standard or sensitive version
 Immersion cleanable
 Printed circuit terminals
 Pin arrangement for 2,54 mm grid
 in acc. with EN 60097 and DIN 40803
 Approx. weight 9,5 g

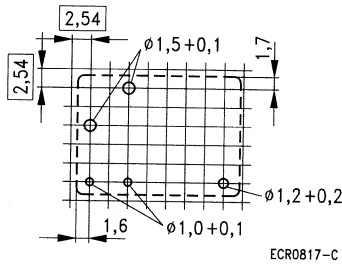
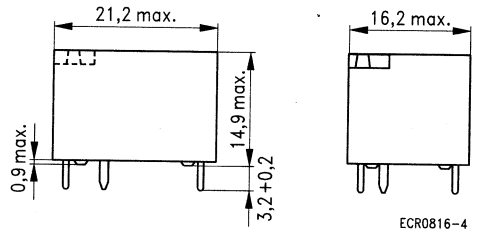

Mounting hole layout
 View from the wiring side

Base terminals

1 changeover contact

1 make contact

1 break contact

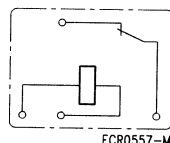
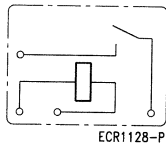
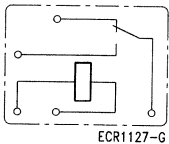

Version	standard ($P_N = 0,45 \text{ W}$)	sensitive ($P_N = 0,33 \text{ W}$)
Contact material	silver nickel 10	
Contact ratings:		
Max. switching voltage	60 Vdc/250 Vac	
Max. continuous current	7 A	5 A
Max. power rating	40 ... 170 W (voltage-dependent) 1750 VA	40 ... 120 W (voltage-dependent) 1250 VA
Minimum contact load	0,1 A/6 Vdc/Vac	

Note: Versions for a maximum continuous current of 10 A, with contacts made of AgCdO_2 or AgSnO_2 are available upon request.

Miniature Power Relays U

Rated voltage	Voltage range at 20°C	Coil resistance at 20°C ± 10 % Ω	Ordering code	DU																
Vdc	Vdc		V23148-	Pcs																
standard version, 1 changeover contact																				
6	4,3 ... 7,8	80	A3-A101	25																
12	8,6 ... 15,6	320	A5-A101	25																
24	17,3 ... 31,2	1280	A7-A101	25																
standard version, 1 make contact																				
6	4,3 ... 7,8	80	A3-B101	25																
12	8,6 ... 15,6	320	A5-B101	25																
24	17,3 ... 31,2	1280	A7-B101	25																
standard version, 1 break contact																				
6	4,3 ... 7,8	80	A3-C101	25																
12	8,6 ... 15,6	320	A5-C101	25																
24	17,3 ... 31,2	1280	A7-C101	25																
sensitive version, 1 changeover contact																				
6	4,5 ... 9,6	110	A103-A101	25																
12	9,0 ... 19,0	440	A105-A101	25																
24	18,0 ... 38,4	1780	A107-A101	25																
sensitive version, 1 make contact																				
6	4,5 ... 9,6	110	A103-B101	25																
12	9,0 ... 19,0	440	A105-B101	25																
24	18,0 ... 38,4	1780	A107-B101	25																
sensitive version, 1 break contact																				
6	4,5 ... 9,6	110	A103-C101	25																
12	9,0 ... 19,0	440	A105-C101	25																
24	18,0 ... 38,4	1780	A107-C101	25																

Relays

Miniature Power Relays UB

V23148-B★★★

Remanent relays
 For dc operation, bistable
 1 changeover contact,
 1 make or 1 break contact
 Immersion cleanable
 Printed circuit terminals
 Pin arrangement for 2,54 mm grid
 in acc. with EN 60097 and DIN 40803

Approx. weight 9,5 g

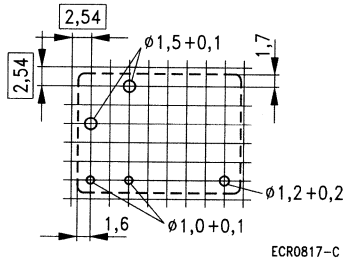
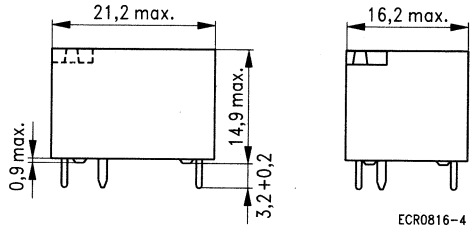

Mounting hole layout
 View from the wiring side

Base terminals

Circuit symbols drawn in OFF position.

1 changeover contact

1 make contact

1 break contact

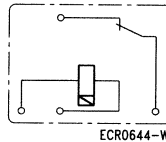
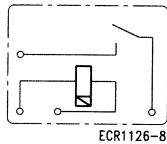
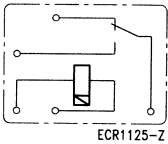

Version	Standard ($P_N = 1 - 1,4 \text{ W}$)
Contact material	silver nickel 10
Contact ratings:	
Max. switching voltage	60 Vdc/250 Vac
Max. continuous current	7 A
Max. power rating	40 ... 250 W (voltage-dependent)
	1750 VA
Recomm. min. contact load	0,1 A/5 Vdc/Vac

Note: Versions for a maximum continuous current of 10 A, with contacts made of AgCdO_2 or AgSnO_2 are available upon request.

Miniature Power Relays UB

Rated voltage	Voltage range at 20 °C	Coil resistance at 20 °C ± 10 %	Ordering code	DU													
Vdc	Vdc	Ω	V23148-	Pcs													
1 changeover contact																	
6	4,8 ... 6,0	33	B3-A101	25													
12	9,6 ... 12,0	119	B5-A101	25													
24	19,2 ... 24,0	475	B7-A101	25													
1 make contact																	
6	4,8 ... 6,0	33	B3-B101	25													
12	9,6 ... 12,0	119	B5-B101	25													
24	19,2 ... 24,0	475	B7-B101	25													
1 break contact																	
6	4,8 ... 6,0	33	B3-C101	25													
12	9,6 ... 12,0	119	B5-C101	25													
24	19,2 ... 24,0	475	B7-C101	25													

Relays

Miniature Power Relays N

V23016-A★★★

For dc operation, neutral, monostable, 1 changeover contact
Terminals for 2,8 mm push-on connectors in acc. with DIN 46245 or DIN 46247

Approvals: DEMKO, NEMKO, SEV, CSA, UL

Approx. weight 15 g

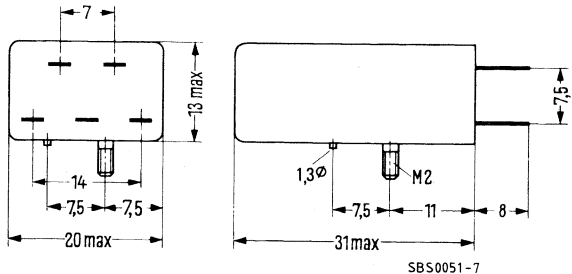

Base terminals

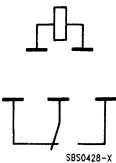

The relay V23016-A ... is fixed by means of a screw and a nut M2.

Contact material		silver, gold-flashed	silver nickel	silver cadmium oxide
Max. switching voltage	V	250 ac/dc		
Max. switching current ¹⁾	A	15		
Max. power rating for DC voltage	W	55 ... 420 (voltage-dependent)	up to 24 V: 150 30 V: 100 200 V: 30 250 V: 50	35 ... 400 (voltage-dependent)
	W			
	W			
	W			
for AC voltage	VA	3750		
Max. continuous current	A	7,5		

Rated voltage	Voltage range at 20 °C	Coil resistance at 20 °C ± 15 %	Ordering code	DU										
Vdc	Vdc	Ω	V23016-	Pcs										
contact material silver, gold-flashed														
24	16,8 ... 44	970	A6-A101	20										
contact material silver nickel														
24	16,8 ... 44	970	A6-A201	20										
contact material silver cadmium oxide														
24	16,8 ... 44	970	A6-A401	20										

1) The current of 15 A may flow for a maximum of 4 seconds up to 10 % relative on-time.

Miniature Power Relays N

V23016-B★★★

For dc operation, neutral, monostable
 1 changeover contact
 Printed circuit terminals
 Pin arrangement for 2,5 mm grid in accordance with EN 60097 and DIN 40803
 Approx. weight 15 g

Base terminals

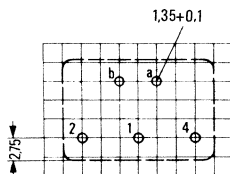
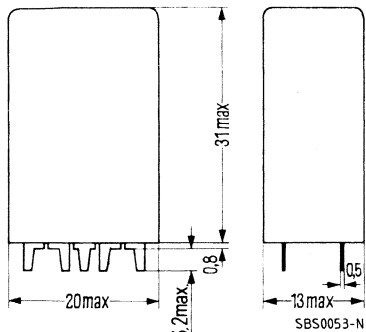
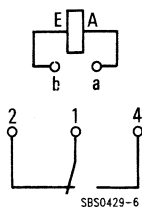

Mounting hole layout
View from the wiring side

Relays

For contact ratings and contact material refer to page 86

Rated voltage	Voltage range at 20°C	Coil resistance at 20°C ± 15 %	Ordering code	DU						
Vdc	Vdc	Ω	V23016-	Pcs						

contact material silver, gold-flashed

12	8,3 ... 22	230 ¹⁾	B5-A101	20						
24	16,8 ... 44	970	B6-A101	20						

contact material silver nickel

24	16,8 ... 44	970	B6-A201	20						
----	-------------	-----	---------	----	--	--	--	--	--	--

1) ± 10 %

Miniature Power Relays N

V23016-C★★★

For dc operation, neutral, monostable,
 1 changeover contact
 Coil terminals for printed circuits in acc.
 with EN 60097 and DIN 40803
 Contact terminals for 2,8 mm push-on
 connectors in acc. with DIN 46245
 or DIN 46247

Approx. weight 16 g

Base terminals

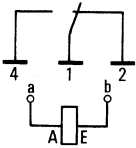

SBS0430-9

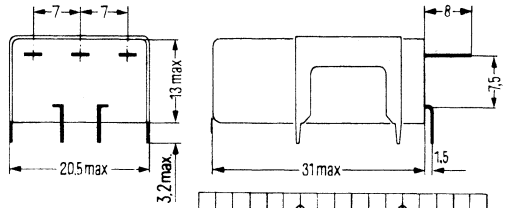

Mounting hole layout
 View from the wiring side

For contact ratings and contact material refer to page 86

Rated voltage	Voltage range at 20 °C	Coil resistance at 20 °C ± 10 %	Ordering code	DU										
Vdc	Vdc	Ω	V23016-	Pcs										
contact material silver, gold-flashed														
12	8,3 ... 22	230	C5-A101	20										
24	16,8 ... 44	970 ¹⁾	C6-A101	20										
contact material silver nickel														
12	8,3 ... 22	230	C5-A201	20										
24	16,8 ... 44	970 ¹⁾	C6-A201	20										

1) ± 15 %

Miniature Power Relays N

V23016-D***-A*0*** with screw
V23016-D***-A*9*** with solder pin
 for additional fixing

For dc operation, neutral, monostable
 1 changeover contact
 Printed circuit terminals
 Pin arrangement for 2,5 mm grid in acc.
 with EN 60097 and DIN 40803

Approx. weight 18 g

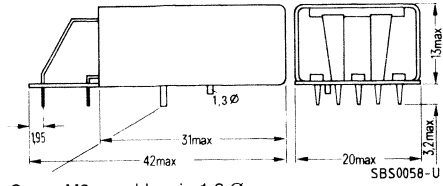

Screw M2 or solder pin 1,3 Ø
 2,2 foot 6,0513 336.676

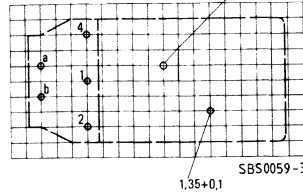

Mounting hole layout
 View from the wiring side

Base terminals

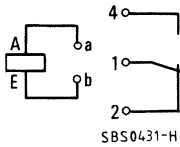

The relay V23016-D*****-A*0* is fixed by means of a screw and a nut M2

For contact ratings and contact material refer to page 86

Rated voltage	Voltage range at 20 °C	Coil resistance at 20 °C ± 10 %	Ordering code	DU						
Vdc	Vdc	Ω	V23016-	Pcs						
contact material silver, gold-flashed										
12	8,3 ... 22	230	D5-A101	20						
24	16,8 ... 44	970 ¹⁾	D6-A101	20						
24	16,8 ... 44	970 ¹⁾	D6-A191	20						
contact material silver nickel										
24	16,8 ... 44	970 ¹⁾	D6-A291	20						

1) ± 15 %

SIE:T7N

For dc operation, neutral, monostable, with
1 changeover contact or 1 make contact
Sensitive version
Immersion cleanable
Printed circuit terminals

Approvals: VDE, UL
(AgSnO₂ approval
applied for)

Approx. weight 12 g

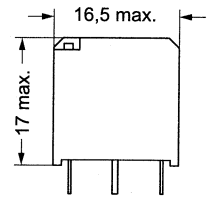
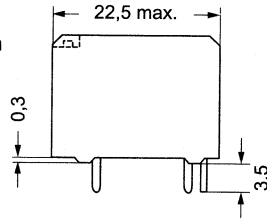

ECR2395-X

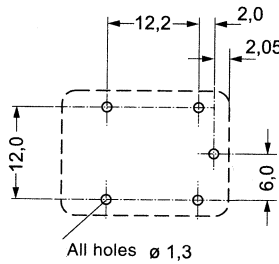

Mounting hole layout
View from the wiring
side

Base terminals

1 changeover contact

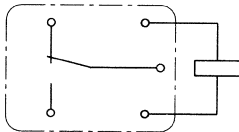

ECR0784-W

1 make contact

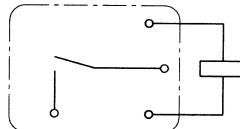

ECR0785-5

Contact ratings:

Max. switching voltage	250 Vac/100 Vdc
Max. switching current	10 A
Max. continuous current max.	10 A (at 85 °C)
Max. power rating	280 W (voltage-dependent) 2500 VA

Contact material: Silver cadmium oxide or silver-tin-oxide

Rated voltage	Voltage range at 20°C	Coil resistance at 20°C ± 10 %	Ordering code	DU									
Vdc	Vdc	Ω	SIE:T7N	Pcs									
1 changeover contact, contact material silver cadmium oxide													
12	8,4 ... 25	400	S5D1-12	25									
24	16,8 ... 50	1600	S5D1-24	25									
1 changeover contact, contact material silver tin oxide													
12	8,4 ... 25	400	S5D4-12	25									
24	16,8 ... 50	1600	S5D4-24	25									
1 make contact, contact material silver cadmium oxide													
12	8,4 ... 25	400	S1D1-12	25									
24	16,8 ... 50	1600	S1D1-24	25									
1 make contact, contact material silver tin oxide													
12	8,4 ... 25	400	S1D4-12	25									
24	16,8 ... 50	1600	S1D4-24	25									

Relays

Power Relays T9A

POT:T9A

For dc operation, neutral, monostable
 1 changeover or 1 make contact
 Immersion cleanable
 Printed circuit terminals

Approvals: CSA, UL, VDE

Approx. weight 30 g

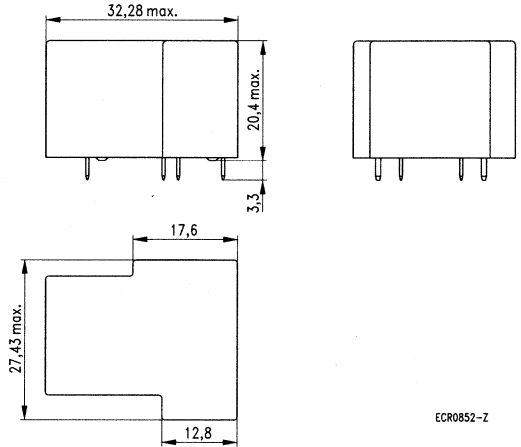

Base terminals

1 make contact

1 changeover contact

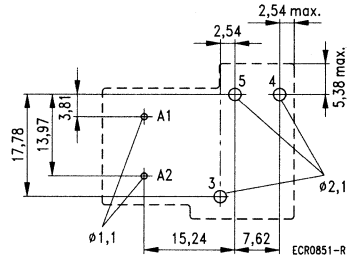
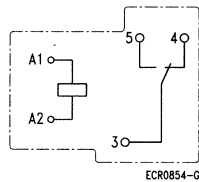
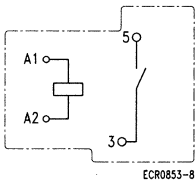

Mounting hole layout
View from the wiring side

Contact material	silver cadmium oxide	
Contact arrangement	1 make contact	1 changeover contact
Contact ratings:		
Max. switching voltage	150 Vdc/480 Vac	150 Vdc/480 Vac
Max. switching current	30 A	20 A
Max. continuous current	30 A	20 A
Max. power rating	560 W/7500 VA	560 W/5000 VA

Power Relays T9A

Rated voltage	Voltage range at 20°C	Coil resistance at 20°C ± 10 % Ω	Ordering code	DU											
Vdc	Vdc		POT:T9A	Pcs											
1 make contact															
◆ 12	9 ... 14,4	144	S1D12-12	250											
◆ 24	18 ... 28,8	576	S1D12-24	250											
1 changeover contact															
◆ 12	9 ... 14,4	144	S5D12-12	250											
◆ 24	18 ... 28,8	576	S5D12-24	250											

Relays

ZT Miniature Relays

2/4pole, 5 A

ZT2★★★ 2 changeover contacts, IP 40

ZT5★★★ 4 changeover contacts, IP 40,
with additional insulating ribs Sep sp

For dc or ac operation, neutral, monostable

PCB mounting or plug-in, AMP 2,8 (solder terminals)

Mechanical and electrical operating
state indicator (option)

With test button; new test button system:

- protected against accidental contact
- can be locked by means of a lever
integrated into the cap S
- test button can be operated from the front

White label for markings

Contact material cadmium free

Approvals: VDE, SEV, UL, CSA

Approximate weight: 31 g

Base terminals

ZT2 2 changeover contacts, 2pole

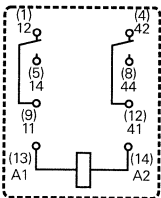

S0167-BC

ZT5 4 changeover contacts, 4pole

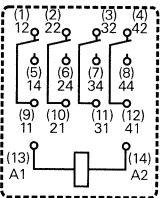

S0167-BB

Solder pins
or plug-in terminals

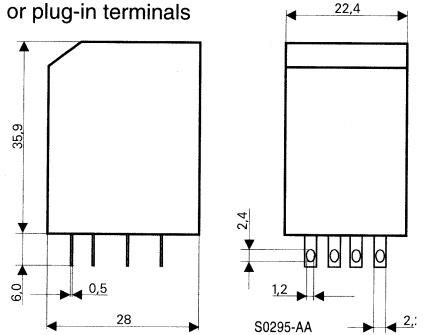

PCB-mounting
terminals

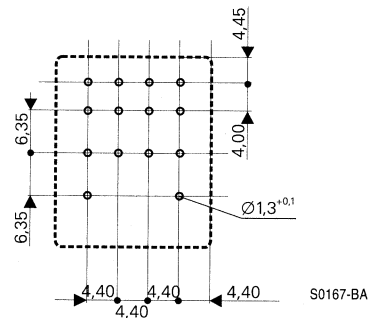
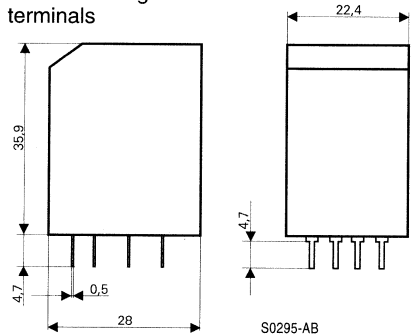

Mounting hole layout
View from the wiring side

ZT Miniature Relays

Rated voltage	250 Vac
Max. contact voltage	440 Vac
Rated current	5 A
Make current (max. 4 s at 10 % duty cycle)	10 A
Nominal power rating	1250 VA

Contact material: AgNi 90/10

Rated voltage	Voltage range at 20 °C	Coil resistance at 20 °C	Ordering code	DU					
Vdc/Vac	Vdc/Vac	Ω		Pcs					

DC operating voltage
PCB mounting terminals, 4 changeover contacts

24	18,0 ... 38,4	520 ± 10 %	ZT571024	25					
----	---------------	------------	----------	----	--	--	--	--	--

plug-in terminals, 2 changeover contacts

24	18,0 ... 38,4	520 ± 10 %	ZT270024	25					
----	---------------	------------	----------	----	--	--	--	--	--

plug-in terminals, 4 changeover contacts

12	9,0 ... 19,2	160 ± 10 %	ZT570012	25					
24	18,0 ... 38,4	520 ± 10 %	ZT570024	25					
48	36,0 ... 76,8	2100 ± 10 %	ZT570048	25					
60	45,0 ... 96,0	3300 ± 12 %	ZT570060	25					
110	82,5 ... 176,0	12000 ± 15 %	ZT570110	25					
220	165,0 ... 352,0	44000 ± 15 %	ZT570220	25					

plug-in terminals, 4 changeover contacts, with LED

24	18,0 ... 38,4	520 ± 10 %	ZT570L24	25					
----	---------------	------------	----------	----	--	--	--	--	--

plug-in terminals, 4 changeover contacts, with LED and recovery diode

24	18,0 ... 38,4	520 ± 10 %	ZT570LC4	25					
----	---------------	------------	----------	----	--	--	--	--	--

AC operating voltage
plug-in terminals, 2 changeover contacts

24	19,2 ... 26,4	176 ± 10 %	ZT270524	25					
230	184,5 ... 253,0	17100 ± 15 %	ZT270730	25					

plug-in terminals, 4 changeover contacts

12	9,6 ... 13,2	45 ± 10 %	ZT570512	25					
24	19,2 ... 26,4	176 ± 10 %	ZT570524	25					
48	38,4 ... 52,8	740 ± 10 %	ZT570548	25					
115	92,0 ... 126,5	4300 ± 12 %	ZT570615	25					
230	184,5 ... 253,0	17100 ± 15 %	ZT570730	25					

plug-in terminals, 4 changeover contacts, with LED

24	19,2 ... 26,4	176 ± 10 %	ZT570R24	25					
230	184,5 ... 253,0	17100 ± 15 %	ZT570T30	25					

For accessories, refer to page 98

2pole 12 A, 3pole 10 A, 4pole 6 A

PT2★★★ 2 changeover contacts

PT3★★★ 3 changeover contacts

PT5★★★ 4 changeover contacts

for dc or ac operation, neutral, monostable

PCB-mounting or plug-in, AMP 2,8 (solder terminals)

Mechanical operating state indicator

With test button

- protected against accidental contact

- type of locking selectable

White label for markings

Contact material cadmium-free

Approvals: VDE; UL, CSA being prepared for

Approximate weight 30 g

Solder pins or
plug-in terminals

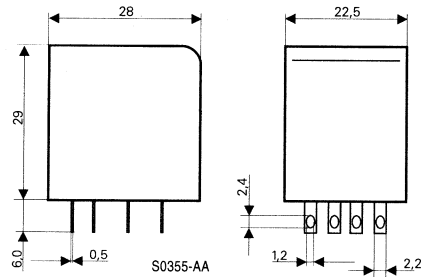

PCB-mounting terminals

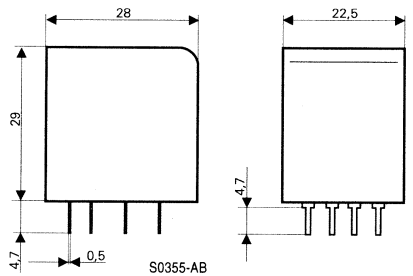

Base terminals

PT2 2 changeover contacts, 2pole

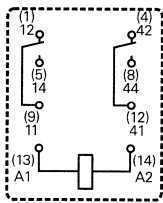

S0354-AF

PT3 3 changeover contacts, 3pole

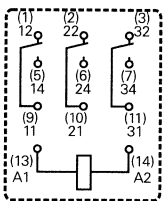

S0354-AE

PT5 4 changeover contacts, 4pole

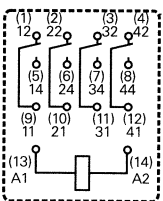

S0354-AD

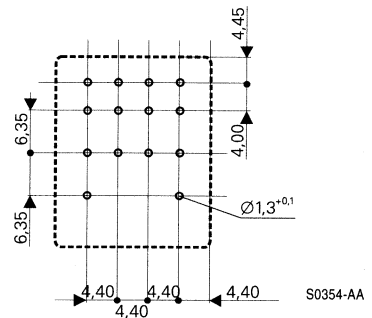

Mounting hole layout
View from the wiring side

Version	2pole	3pole	4pole
Rated voltage	250 Vac		
Maximum contact voltage	440 Vac		
Rated current	12 A	10 A	6 A
Make current (max. 4s at 10% duty cycle)	24 A	20 A	12 A
Nominal power rating	3000 VA	2500 VA	1500 VA

Contact material: AgNi 90/10

Rated voltage	Voltage range at 20°C	Coil resistance at 20°C	Ordering code	DU										
Vdc/Vac	Vdc/Vac	Ω		Pcs										

DC operating voltage

PCB mounting terminals, 4 changeover contacts

24	18,0 ... 40,8	777 ± 10 %	PT571024	10										
----	---------------	------------	----------	----	--	--	--	--	--	--	--	--	--	--

plug-in terminals, 2 changeover contacts

24	18,0 ... 40,8	777 ± 10 %	PT270024	10										
----	---------------	------------	----------	----	--	--	--	--	--	--	--	--	--	--

plug-in terminals, 3 changeover contacts

24	18,0 ... 40,8	777 ± 10 %	PT370024	10										
----	---------------	------------	----------	----	--	--	--	--	--	--	--	--	--	--

plug-in terminals, 4 changeover contacts

24	18,0 ... 40,8	777 ± 10 %	PT570024	10										
----	---------------	------------	----------	----	--	--	--	--	--	--	--	--	--	--

AC operating voltage

plug-in terminals, 2 changeover contacts

24	19,2 ... 39,4	192 ± 10 %	PT270524	10										
115	92,0 ... 189,8	4845 ± 12 %	PT270615	10										
230	184,0 ... 380,0	19465 ± 15 %	PT270730	10										

plug-in terminals, 3 changeover contacts

24	19,2 ... 39,4	192 ± 10 %	PT370524	10										
115	92,0 ... 189,8	4845 ± 12 %	PT370615	10										
230	184,0 ... 380,0	19465 ± 15 %	PT370730	10										

plug-in terminals, 4 changeover contacts

24	19,2 ... 39,4	192 ± 10 %	PT570524	10										
115	92,0 ... 189,8	4845 ± 12 %	PT570615	10										
230	184,0 ... 380,0	19465 ± 15 %	PT570730	10										

Note: The above order data are only an excerpt from our current complete product range. Other models and coil voltages are available upon request.

ZT/PT Miniature Relays Accessories

Sockets with screw terminals

ZG78700
for ZT/PT-relay 2/4pole,
max. 6 A
and ZG78110
with protection diode
for ZT/PT-relay 2/4pole,
max. 6 A

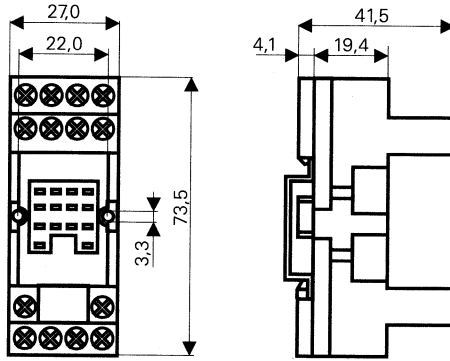

S0320-AA

PT78702
for PT-relay 2pole
and
PT78703
for PT-relay 3pole
and
PT78704
for PT-relay 4pole

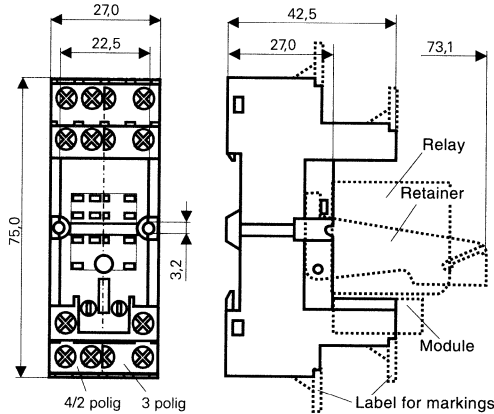

S0356-AD

Sockets with soldering terminals

ZG78750
for ZT/PT-relay 2/4pole,
max. 6 A

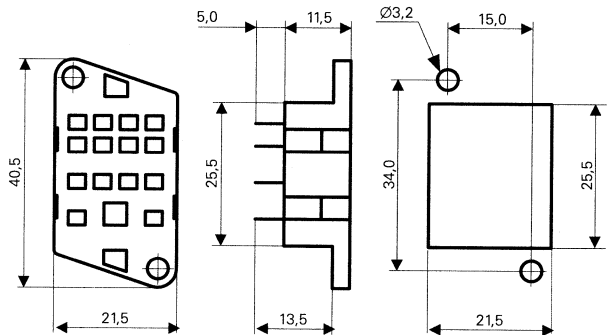

S0308-AA

Mounting hole layout

ZT/PT Miniature Relays Accessories

ZG78753
for ZT/PT-relays 2/4pole,
max. 6 A

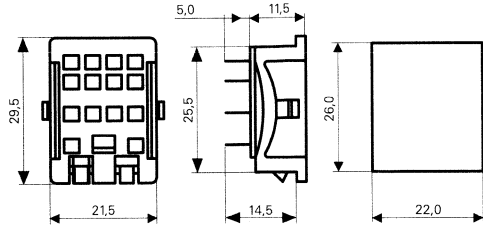

S0308-AC

Mounting hole layout

Socket with PCB mounting terminals

ZG78752
for ZT/PT-relays 2/4pole,
max. 6 A

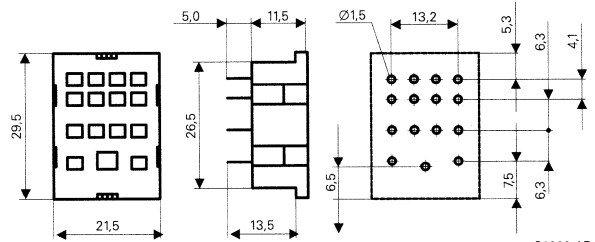

S0308-AB

Mounting hole layout
View from the wiring side

ZG78759
for ZT/PT-relays 2pole,
max. 10 A

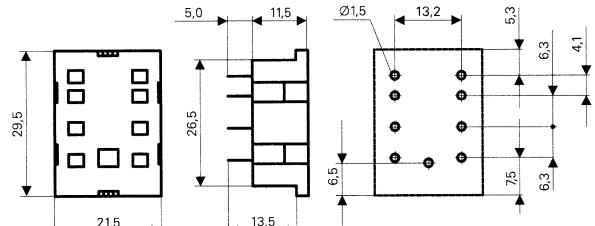

S0308-AD

Mounting hole layout
View from the wiring side

ZT/PT Miniature Relays Accessories

Accessories	Ordering code	DU								
		Pcs								

Socket with screw terminals ZG ..., for DIN mounting rails

4-pole	ZG78700	25							
4-pole, with protection diode	ZG78110	25							
Metal retainer clip for PT relays	PT28800	10							
Metal retainer clip for ZT relays	ZG28801	25							

Socket with screw terminals PT ..., for DIN mounting rails

NEW 2-pole	PT78702	10							
NEW 3-pole	PT78703	10							
NEW 4-pole	PT78704	10							
NEW plastic retainer	PT16016	10							
NEW metal retaining clip	PT28800	10							
NEW label for markings	PT16040	10							

Protective modules for sockets PT ...

NEW RC-combination 24/48 Vac	RPMU0548	20							
NEW RC-combination 110/230 Vac	RPMU0730	20							
NEW Protection diode (Type 1N 4007)	RPMT00A0	20							

Indicator modules for sockets PT ...

NEW LED module 12/24 Vac	RPML0024	20							
NEW LED module 12/24 Vdc/Vac	RPML0524	20							
NEW LED module 110 Vac	RPML0110	20							
NEW LED module 110/230 Vac	RPML0730	20							

Sockets with solder terminals ZG ...

4-pole with mounting holes	ZG78750	25							
4-pole	ZG78753	25							

Sockets with PCB-mounting terminals ZG ...

4-pole	ZG78752	25							
2-pole	ZG78759	25							
Metal retainer clip for ZT relays	ZG28800	25							

MT Multimode Relays

2 pole/3 pole, 10 A

MT2★★★ 2 changeover contacts, 8pole
MT3★★★ 3 changeover contacts, 11pole

For dc and ac operating voltage,
 neutral, monostable

Mechanical and optional
 electrical operating state indicator (LED)

- With test lever; new test lever system:
- protection against accidental contact
 - can be locked by means of lever integrated in the cap S
 - test button can be operated from the front

White label for marking

Contact material cadmium free

Approvals: VDE, SEV, UL, CSA, ÖVE, NEMKO

Approximate weight: 80 g

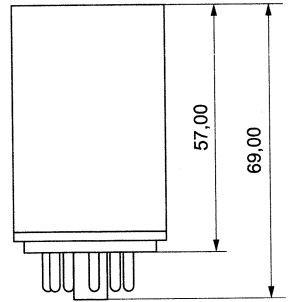

Relays

Base terminals

MT2 2 changeover contacts, 8pole

MT3 3 changeover contacts, 11pole

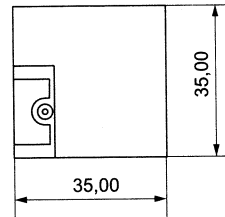

ECR1250-L

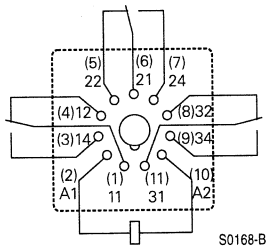
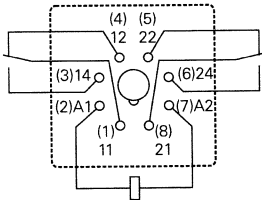

S0168-B

Rated voltage	250 Vac
Max. contact voltage	440 Vac
Rated current	10 A
Make current (max. 4 s at duty cycle < 10 %)	20 A
Nominal power rating	2500 VA

Contact material: AgNi 90/10

MT Multimode Relays

Rated voltage	Voltage range at 20°C	Coil resistance at 20°C	Ordering code	DU														
Vdc/Vac	Vdc/Vac	Ω		St.														

DC operating voltage
2 changeover contacts

12	9,0 ... 18,6	110 ± 10 %	MT221012	25														
24	18,0 ... 37,2	475 ± 10 %	MT221024	25														
48	36,0 ... 74,4	2000 ± 10 %	MT221048	25														

3 changeover contacts

12	9,0 ... 18,6	110 ± 10 %	MT321012	25														
24	18,0 ... 37,2	475 ± 10 %	MT321024	25														
48	36,0 ... 74,4	2000 ± 10 %	MT321048	25														
110	82,5 ... 170,5	10000 ± 12 %	MT321110	25														
220	165,0 ... 341,0	40000 ± 15 %	MT321220	25														

3 changeover contacts, with recovery diode (polarity + 2/- 10)

24	18,0 ... 37,2	475 ± 10 %	MT3210C4	25														
----	---------------	------------	----------	----	--	--	--	--	--	--	--	--	--	--	--	--	--	--

3 changeover contacts, electrical operating state indicator

24	18,0 ... 37,2	475 ± 10 %	MT323024	25														
----	---------------	------------	----------	----	--	--	--	--	--	--	--	--	--	--	--	--	--	--

3 changeover contacts, electrical operating state indicator, recovery diode (polarity + 2/- 10)

24	18,0 ... 37,2	475 ± 10 %	MT3230C4	25														
----	---------------	------------	----------	----	--	--	--	--	--	--	--	--	--	--	--	--	--	--

3 changeover contacts, contact material AgNi 90/10 + htv

24	18,0 ... 37,2	475 ± 10 %	MT331024	25														
----	---------------	------------	----------	----	--	--	--	--	--	--	--	--	--	--	--	--	--	--

AC operating voltage
2 changeover contacts

24	19,2 ... 30,0	86 ± 10 %	MT226024	25														
48	38,4 ... 60,0	345 ± 10 %	MT226048	25														
115	92,0 ... 143,8	2000 ± 10 %	MT226115	25														
230	184,0 ... 287,5	8300 ± 12 %	MT226230	25														

3 changeover contacts

12	9,6 ... 15,0	24 ± 10 %	MT326012	25														
24	19,2 ... 30,0	86 ± 10 %	MT326024	25														
48	38,4 ... 60,0	345 ± 10 %	MT326048	25														
115	92,0 ... 143,8	2000 ± 10 %	MT326115	25														
230	184,0 ... 287,5	8300 ± 12 %	MT326230	25														

3 changeover contacts, electrical operating state indicator

24	19,2 ... 30,0	24 ± 10 %	MT328024	25														
115	92,0 ... 143,8	2000 ± 10 %	MT328115	25														
230	184,0 ... 287,5	8300 ± 12 %	MT328230	25														

MT Multimode Relays Accessories

Accessories		Ordering code	DU									
			Pcs									
Function modules: rated voltage 24 ... 240 Vdc / Vac, 48 ... 63 Hz, time ranges 0,05 s ... 240 h in eight separate ranges, can be switched over.												
IEW with delay ON		MTMZ0W00	5									
IEW multifunction		MTMF0W00	5									
Protective modules												
IEW RC-combination	24 Vac/115 Vac	MTMU0524	20									
IEW RC-combination	230 Vac	MTMU0730	20									
IEW protection diode (Type 1N 4007)		MTMT00A0	20									
Indicator modules												
IEW LED module	24 Vdc / Vac	MTML0024	20									
IEW LED module	115/230 Vac	MTML0730	20									

Relays

MT Multimode Relays Accessories

Sockets with screw terminals

MT78740 and MT78745

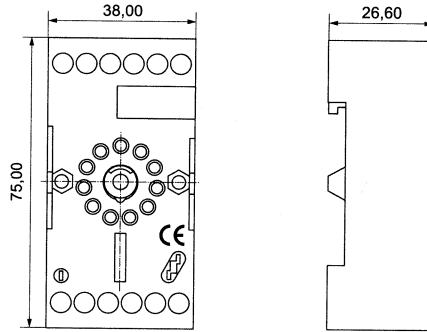

ECR2396-6

MR78750 and MR78755

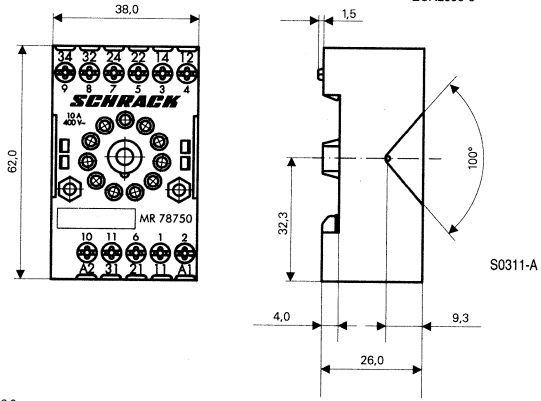

S0311-A

Sockets with soldering terminals

MR78710 and MR78711

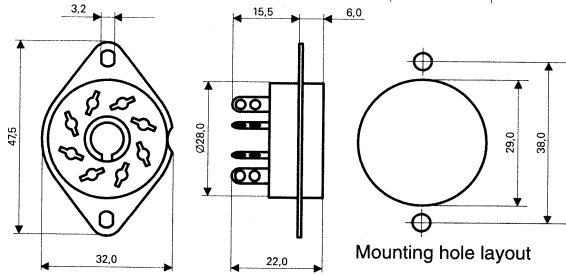

Mounting hole layout S0309-AA

Socket with PCB mounting terminals

MR78712

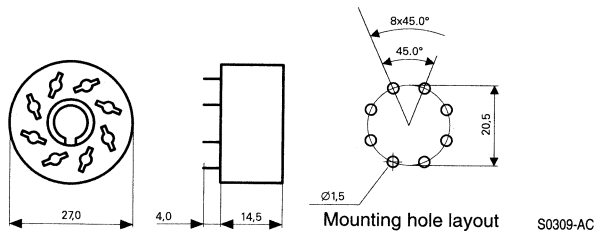

Mounting hole layout S0309-AA

MT Multimode Relays Accessories

Socket with PCB mounting terminals

MR78713

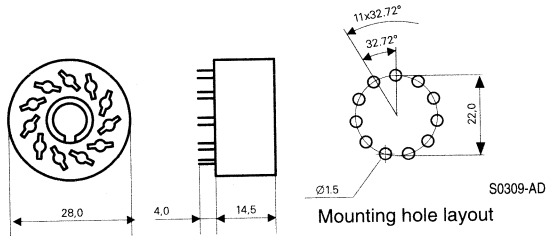

Socket with PCB mounting terminals

RN78731
for quick connects
2 × 2,8 × 0,8

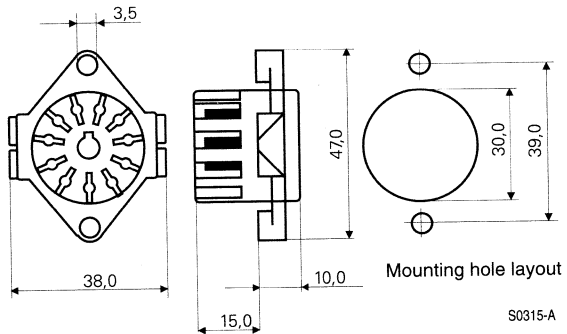

Relays

Accessories	Ordering code	DU													
			Pcs												
NEW Socket with screw terminals, 11pole	MT78740	10													
NEW Socket with screw terminals, 8pole	MT78745	10													
Socket with screw terminals without module connector, 11 pole	MR78750	25													
Socket with screw terminals without module connector, 8 pole	MR78755	25													
Retaining clip for MR socket	MR28800	25													
Socket with soldering terminals, 11 pole	MR78711	25													
Socket with soldering terminals, 8 pole	MR78710	25													
Socket with PCB mounting terminals, 11 pole	MR78713	25													
Socket with PCB mounting terminals, 8 pole	MR78712	25													
Socket with PCB mounting terminals, 11 pole, for quick connects	RN78731	25													

Power Relays T92

POT:T92

For dc or ac operation, neutral, monostable
 2 changeover or 2 make contacts
 Immersion cleanable
 Printed circuit terminals

Approvals: CSA, UL, VDE

Approx. weight 80 g

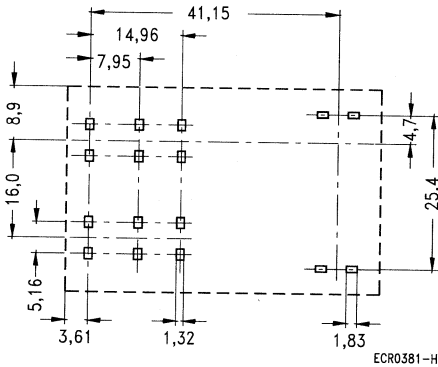
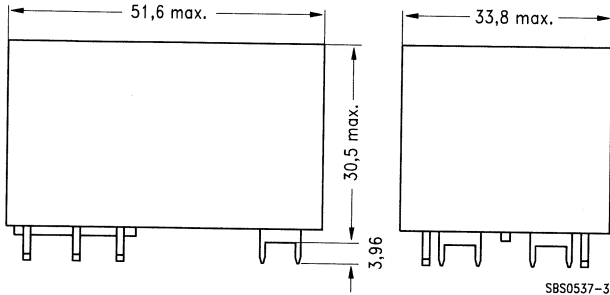

Mounting hole layout
 View from the wiring side

Note: Rectangular mounting holes (as shown in the figure) are recommended to enhance solderability, round holes with $\varnothing 1,83 \pm 0,13$ mm, however, are also possible.

Base terminals

2 changeover contacts

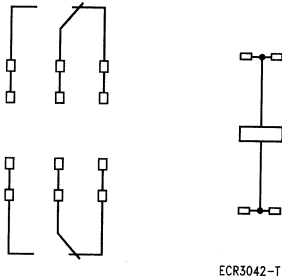

2 make con-

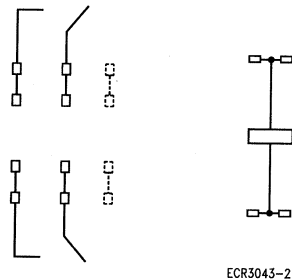

Power Relays T92

Relays

Contact material	Make contact side silver cadmium oxide	Break contact side silver	silver cadmium oxide
Contact arrangement	2 changeover contacts		2 make contacts
Contact ratings:	150 Vdc/480 Vac		150 Vdc/480 Vac
Max. switching voltage			30 A
Max. switching current	30 A	3 A	30 A
Max. continuous current	30 A	3 A	30 A
Max. power rating	560 W	84 W	560 W
	7500 VA	750 VA	7500 VA

Rated voltage	Voltage range at 25°C	Coil resistance at 25°C ± 10 %	Ordering code	DU											
	Vdc/Vac	Ω	POT:T92	Pcs											

DC voltage, 2 changeover contacts

◆ 12Vdc	9 ... 15,7	86	S11D12-12	30											
◆ 24 Vdc	18 ... 31,7	350	S11D12-24	30											

DC voltage, 2 make contacts

◆ 12Vdc	9 ... 15,7	86	S7D12-12	30											
◆ 24 Vdc	18 ... 31,7	350	S7D12-24	30											

AC voltage, 2 make contacts

◆ 240 Vac	192 ... 264	3800	S7A12-240	30											
-----------	-------------	------	-----------	----	--	--	--	--	--	--	--	--	--	--	--

Power Relays T92

POT:T92

For dc or ac operation,
neutral, monostable
2 changeover or
2 make contacts,
With quick connects
for 4,75 mm or 6,35 mm
push-on connectors
For screw fixing

Approvals: CSA, UL, VDE

Approx. weight 84 g

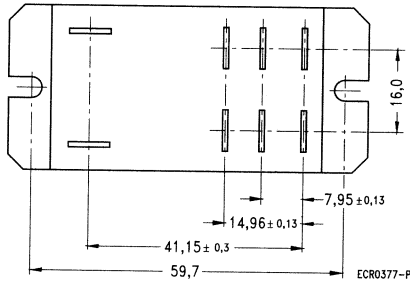
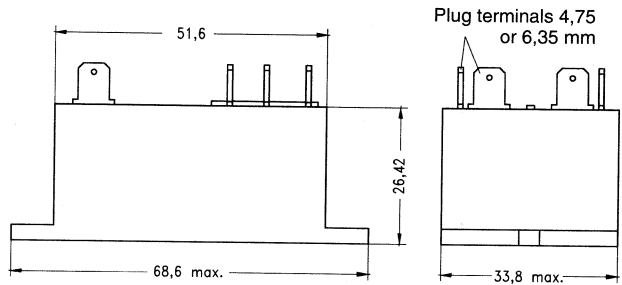

For contact material, contact ratings and base terminals refer to page 106

Rated voltage	Voltage range at 25 °C	Coil resistance at 25 °C ± 10 %	Ordering code	DU							
	Vdc/Vac	Ω	POT:T92	Pcs							

DC voltage, 2 changeover contacts

◆ 12 Vdc	9 ... 15,7	86	P11D22-12	30							
◆ 24 Vdc	18 ... 31,7	350	P11D22-24	30							

AC voltage, 2 changeover contacts

◆ 24 Vac	19,2 ... 26,4	39	P11A22-24	30							
◆ 240 Vac	192 ... 264	3800	P11A22-240	30							

DC voltage, 2 make contacts

◆ 12 Vdc	9 ... 15,7	86	P7D22-12	30							
◆ 24 Vdc	18 ... 31,7	350	P7D22-24	30							

AC voltage, 2 make contacts

◆ 24 Vac	19,2 ... 26,4	39	P7A22-24	30							
◆ 240 Vac	192 ... 264	3800	P7A22-240	30							

Safety Relay SR2M

NEW

V23047-A1★★★ with forcibly guided contacts

For dc operation, neutral, monostable
with 1 make contact and 1 break
contact or with 2 changeover contacts

Immersion cleanable

Printed circuit terminals

Approvals: VDE, TÜV, UL, CSA

Approximate weight 18 g

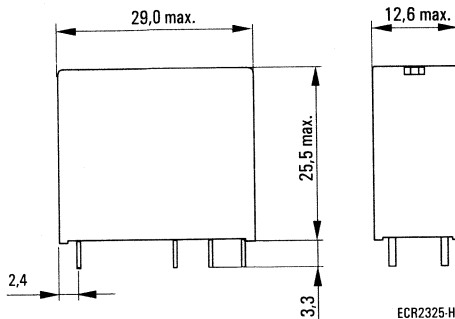

Relays

1 make contact und 1 break contact

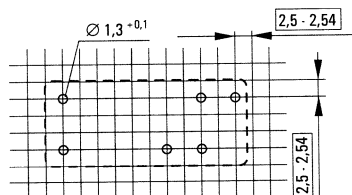

ECR2327-Y

2 changeover contacts

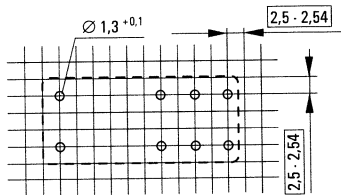

ECR2326-Q

Mounting hole
layout
View from the
wiring side

Base terminals

1 make contact und 1 break contact

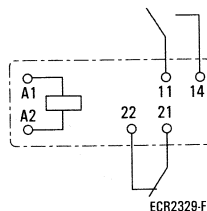

ECR2329-F

2 changeover contacts

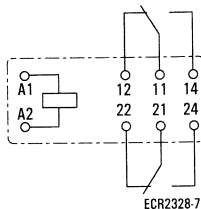

ECR2328-7

Contact ratings:

Max. switching voltage	250 Vdc/Vac
Max. continuous current	6 A
Max. power rating:	90 ... 300 W (depending on voltage)
	1500 VA

Contact material: AgNi

Rated voltage	Voltage range at 20°C	Coil resistance at 20°C	Ordering code	DU								
Vdc	Vdc	Ω	V23047-	Pcs								

1 make contact and 1 break contact

12	9 ... 20	206 ± 21	A1012-A511	20								
18	12,6 ... 30	463 ± 46	A1018-A511	20								
21	15,8 ... 35	630 ± 63	A1021-A511	20								
24	18 ... 40	823 ± 83	A1024-A511	20								

2 changeover contacts

12	9 ... 20	206 ± 21	A1012-A501	20								
18	12,6 ... 30	463 ± 46	A1018-A501	20								
21	15,8 ... 35	630 ± 63	A1021-A501	20								
24	18 ... 40	823 ± 83	A1024-A501	20								

Note: For the suitable sockets RP78602, RT 78625 and RT78626, as well as for diode modules and LED modules RPMLO 024/524, refer to page 78

V23049-B1★★★
with forcibly guided contacts

for dc operation, polarized,
monostable
with 3 make contacts and
1 break contact or
with 2 make contacts and
2 break contacts

Immersion cleanable

Printed circuit terminals

Approvals: VDE, TÜV, CSA, UL

Approximate weight 32 g

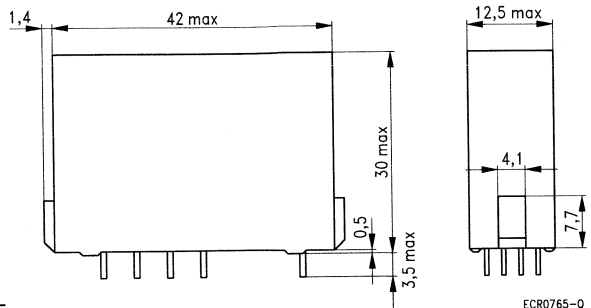

ECR0765-Q

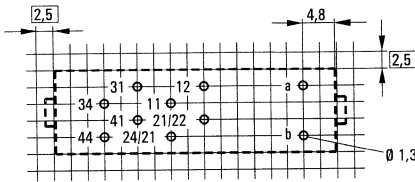

ECR0766-Y

Mounting hole layout
View from the wiring side

Base terminals

3 make contacts und 1 break contact

2 make contacts und 2 break contacts

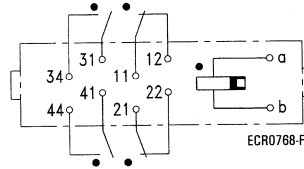
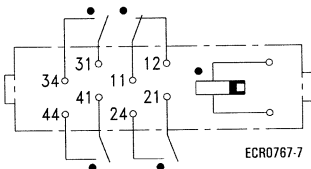

Circuit symbols drawn in OFF position. If a positive potentials is applied to terminal a, the relay assumes the ON position.

Contact material	AgCdO	AgNi 0,15 hard gold-plated
Contact ratings	250 Vdc/Vac	
Max. switching voltage	250 Vdc/Vac	
Switching current	6 A	6 A
load on a single contact	2 A	0,5 A
load on several contacts	6 A	
Max. continuous current	100 ... 360 W (depending on voltage)	
Max. power rating:	1500 VA	

Rated voltage	Voltage range at 20°C	Coil resistance at 20°C ± 10 % Ω	Ordering code	DU										
Vdc	Vdc		V23049-	Pcs										
2 make contacts and 2 break contacts, contact material AgCdO														
12	8,9 ... 24	255	B1005-A122	10										
24	17,8 ... 48	1020	B1007-A122	10										
2 make contacts and 2 break contacts, contact material AgNi 0,15, hard gold-plated														
12	8,9 ... 24	255	B1005-A322	10										
24	17,8 ... 48	1020	B1007-A322	10										
3 make contacts and 1 break contact, contact material AgCdO														
12	8,9 ... 24	255	B1005-A131	10										
24	17,8 ... 48	1020	B1007-A131	10										
3 make contacts and 1 break contact, contact material AgNi 0,15, hard gold-plated														
12	8,9 ... 24	255	B1005-A331	10										
24	17,8 ... 48	1020	B1007-A331	10										

V23050-A1★★★
with forcibly guided contacts

for dc operation, neutral,
monostable
with 4 make contacts and
2 break contacts

Immersion cleanable

Printed circuit terminals

Approvals: VDE, TÜV, UL, CSA
being prepared for

Approximate weight 31 g

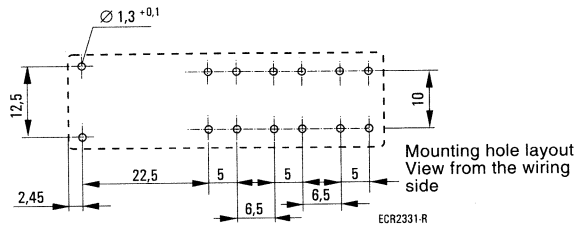
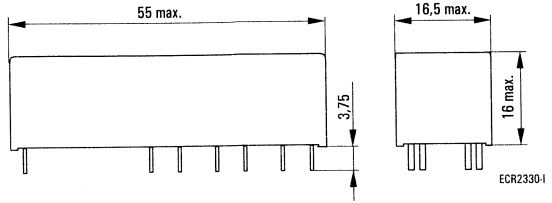

Base terminals

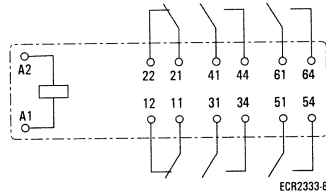

Contact ratings:

Max. switching voltage 250 Vdc/Vac
Switching current 8 A
Max. continuous current 2000 VA
Max. power rating:

Note: given specifications are preliminary and subject to change.

Rated voltage	Minimum voltage	Coil resistance at 20°C ± 10 % Ω	Ordering code	DU									
Vdc	Vdc		V23050-	Pcs									

available as from October 1999

12	9,0	120	A1012-A542	10									
24	18,0	480	A1024-A542	10									

Relays

Solid-State Relays V23100

V23100-S★★★-A★★★ Types A2 and A8

Screw terminals

Approximate weight: 85 g

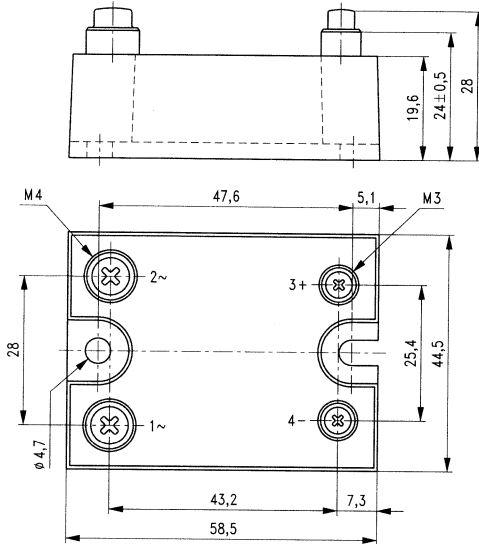

Tolerances: $\pm 0,3$ mm

ECR1055-F

Accessories:

Dust cover V23100-Z2008

Approximate weight: 8 g

V23100-S302-A303 Type A3

Printed circuit terminals

Approximate weight: 22 g

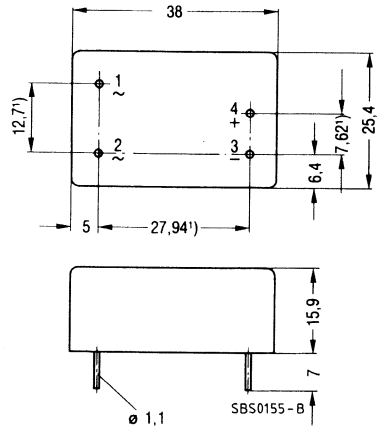

1) Refers to wire outlet through sealing compound.

Solid-State Relays V23100

Type	A2	A2	A2	A8	A3
Ordering code	V23100-S302-A210	V23100-S302-A225	V23100-S302-A240	V23100-S2034-A825	V23100-S302-A303

Load circuit

Zero-point switch		yes	yes	yes	yes	yes
Switching current	I_{rms}	10	25	40	25	3
Switching voltage	V_{rms}	230	230	230	400	230
Switching voltage range	V_{rms}	24 ... 280	24 ... 280	24 ... 280	24 ... 280	24 ... 280
Repetitive peak blocking voltage	V_S	600	600	600	1000	600
Frequency range	Hz	47 ... 63	47 ... 63	47 ... 63	47 ... 63	47 ... 63
Min. load current (holding current)	mA_{rms}	50	50	50	50	50
Zero voltage	V	± 25	± 25	± 25	± 25	± 30
Critical rate of rise of off-state voltage	V/μs	5	5	5	200	5
Peak load integral, 10 ms	A ² s	66	450	800	265	18
Max. operate time	ms	10	10	10	10	10

Control circuit

Control voltage	Vdc	4 ... 30	4 ... 30	4 ... 30	4 ... 30	4 ... 30
Control current at max. control voltage	mA_{dc}	< 20	< 20	< 20	< 20	< 20
Control circuit resistance	Ω	1500	1500	1500	1500	1500

General

Operating temperature range, typ.	°C	-25 ... + 80	-25 ... + 80	-25 ... + 80	-25 ... + 80	-25 ... + 80
Storage temperature range	°C	-40 ... + 100	-40 ... + 100	-40 ... + 100	-40 ... + 100	-40 ... + 100
Test voltage	input – output	kV_{rms}	2,5	2,5	2,5	2,5
	input – case	kV_{rms}	2,5	2,5	2,5	–
	output – case	kV_{rms}	2,5	2,5	2,5	–

Note: To attain the stated current ratings for types A2 and A8, it is necessary to mount the SSRs onto finned heat sinks or flat plates. Apply a heat transfer compound when fitting the relay to the heat sink. At any rate check case temperature.

	Ordering code	DU							
		Pcs							
Solid-state relays	V23100-S302-A210	5							
	V23100-S302-A225	5							
	V23100-S302-A240	5							
	V23100-S2034-A825	5							
	V23100-S302-A303	15							
Dust cover	V23100-Z2008	5							

Solid-State Relay V23107

V23107-S★★★★-B404

Type B4

Printed circuit terminals

Pin arrangement in accordance
with EN 60097

Approvals: VDE, UL

Approximate weight: 20 g

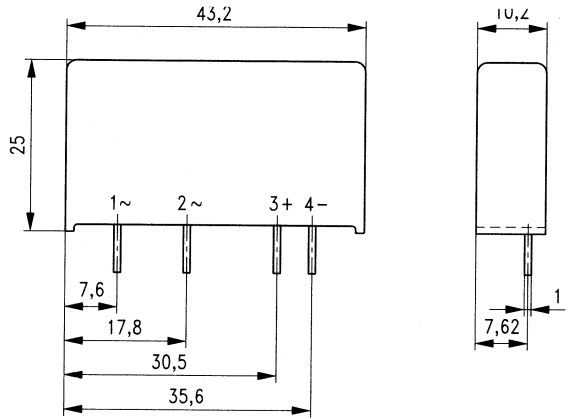

Tolerances: 0,3 mm

ECR1050-9

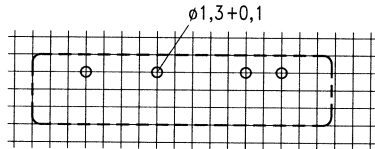

ECR1051-H

Mounting hole layout
View from the wiring side

	Ordering code	DU				
		Pcs				
Solid-state relays	V23107-S4022-B404	10				
	V23107-S4023-B404	10				
	V23107-S4042-B404	10				
	V23107-S4043-B404	10				
	V23107-S4342-B404	10				
	V23107-S4343-B404	10				

Solid-State Relay V23107

Type	B4	B4	B4	B4	B4	B4
Ordering code	V23107- S4022- B404	V23107- S4023- B404	V23107- S4042- B404	V23107- S4342- B404	V23107- S4043- B404	V23107- S4343- B404

Load circuit

Zero-point switch		yes	yes	yes	no	yes	no
Switching current	A_{rms}	4	4	4	4	4	4
Switching voltage	V_{rms}	230	400	230	230	400	400
Switching voltage range	V_{rms}	12 ... 275	12 ... 460	12 ... 275	12 ... 275	12 ... 460	12 ... 460
Repetitive peak blocking voltage	V_S	600	1000	600	600	1000	1000
Max. surge current, 1 cycle 50 Hz, non-repetitive peak current (10 ms) ITSM	A_S	100	100	100	100	100	100
Max. on-state voltage (peak value)	V_S	1,6	1,6	1,6	1,6	1,6	1,6
Frequency range	Hz	10 ... 440	10 ... 440	10 ... 440	10 ... 440	10 ... 440	10 ... 440
Min. switching current (holding current)	mA_{rms}	50	50	50	50	50	50
Zero voltage	V	± 12	± 12	± 12	–	± 12	–
Critical commutation rate of voltage rise	$V/\mu s$	500	500	500	500	500	500
Peak load integral, 10 ms	A^2s	50	50	50	50	50	50
Max. operate time	ms	10	10	10	0,1	10	0,1

Control circuit

Control voltage	Vdc	2,5 ... 10	2,5 ... 10	4 ... 30	3 ... 30	4 ... 30	3 ... 30
Control current at max. control voltage	mA_{dc}	30	30	30	30	30	30
Control circuit resistance	Ω	330	330	1000	1000	1000	1000

General

Operating temperature range, typ.	°C	–40...+ 80	–40...+ 80	–40...+ 80	–40...+ 80	–40...+ 80	–40...+ 80
Storage temperature range	°C	–40...+ 150	–40...+ 150	–40...+ 150	–40...+ 150	–40...+ 150	–40...+ 150
Test voltage							
input – output	kV_{rms}	4,0	4,0	4,0	4,0	4,0	4,0
input – case	kV_{rms}	–	–	–	–	–	–
output – case	kV_{rms}	–	–	–	–	–	–

Product Group Index

	Page
Connectors	
Connectors in accordance with DIN 41 612	123
Insulation-displacement connectors for ribbon cables	150
Connectors Sub-D	163
Connectors in accordance with DIN 41 618 and DIN 41 622	178
Connectors for patch panel applications	187
Coaxial connectors	188

Connectors

New connectors in this edition

Coaxial connectors, BNC series

The BNC coaxial connector series has been designed and is produced in accordance with the highest possible quality criteria. Now some of these connectors have been included in this preferred products list. They are characterized by a 2-stud bayonet coupling which, due to its ease of handling, is an advantage in applications such as test equipment, computers, telecommunications and video systems.

Measuring accessories and tools

In addition to a terminating resistor (75Ω), some extenders (75Ω), plugs and jacks have been included. Also new is a pair of crimping tools for attaching the coaxial connectors to cables. The tools, which have several different inserts for varying hexagonal dimensions, are suitable for small production batches.

SIEMENS

We never

switch off

Modern automotive technology demands the highest standards in reliability. Siemens Electromechanical Components is already delivering a whole raft of outstanding solutions. An airbag connector, for example, that on disconnection from the control unit prevents an unwanted deployment of the air-bag system by linking the terminals. Whatever the circumstances, we never switch off. Our customers value us as a partner who can be reached fast, with the necessary expertise at hand around the world whenever, wherever it's needed.

Does that sound like something you could use? Then get in touch with us!



Components with system vision



Connectors

Contents

Page

Connectors in accordance with DIN 41 612

Technical data	123
Connectors PC 612	
Blade-contact and female connectors, design B and B/2	124
Blade-contact and female connectors, design C and C/2	126
Blade-contact and female connectors, design D	129
Blade-contact and female connectors, design F	131
Blade-contact and female connectors, design G	133
Blade-contact and female connectors, design H	135
Blade-contact and female connectors, design M and M/2	138
Special contacts for blade-contact and female connectors, design M	141
Blade-contact and female connectors, designs Q and Q/2	145
Blade-contact and female connectors, designs R and R/2	147
Housings	149

Insulation-displacement connectors for ribbon cables

PCB connectors	
Dual-in-line connector BK-DIL 368	150
Dual-in-line socket BK-DIL 390	152
PCB connector BK-LEV 413	154
Female connector BK-DIN 389	156
Modular grid connector BK-MOD 421/422	158

Connectors Sub-D

Sub-D with soldering terminal	
Pin and female connectors	165
Angle connectors (pin and female)	168
Sub-D with insulation displacement terminal	
Pin and female connectors	172
Housings	174
Variable housing accessories	175

Connectors in accordance with DIN 41 618 and DIN 41 622

Two-part connectors RP 618	178
Two-part connectors RP 622	180
Two-part connectors RP 300	182
Cable connector housings	183
Matching parts, retaining devices, grounding socket	185
Cable sleeves	186
Polarizing elements	186

Cable connectors

187

Contents

Page

Coaxial Connectors

Series 1,0/2,3 (50 Ω and 75 Ω)	188
Series 1,6/5,6 mS (75 Ω)	190
Series BNC (50/75 Ω)	193
Measuring Accessories	194
Tools	196

Further technical literature and information on our comprehensive product range

CD-ROM „Connectors“ Ordering code A23001-G20-D013-X-7400

Data Book „Steckverbinder DIN 41612 und SIEDECON/Connectors DIN 41612 and SIEDECON“

Ordering code A23001-G21-D012-X-7400

Data Book „Steckverbinder HF/Connectors RF“ Ordering code A23001-G23-D009-X-7400

Data Book „Steckverbinder/Connectors DIN 41617 ... 622; Meßsteckverbinder/Connectors for

Measuring“ Ordering code A23001-G21-D020-X-7400

EC connectors in the Web: <http://www.siemens.de/ec/ecb>

Connectors PC 612

Technical Data

Blade-contact and female connectors

Electrical and mechanical ratings (short form)

Designs in accordance with DIN 41 612	B B/2	C C/2	M M/2	Q Q/2	R R/2	D	F, G	H	
Performance levels in acc. with DIN 41 612	2	2	2	2	2	2	2	1	
Temperature range	- 55°C ... + 125°C								
Current rating at 70 °C	2,3 A			4 A			15 A		
Dielectric strength	1000 V			1500 V			3100 V		
Creepage distance contact/contact	1,2 mm			3 mm			8 mm		
Clearance contact/contact	1,2 mm			3 mm			1,6 mm	4,5 mm	
Contact resistance	≤ 20 mΩ			≤ 15 mΩ			≤ 8 mΩ		
Insulation resistance	≥ 10 ⁶ MΩ								
Terminals ^{*)} for soldering into PCBs wire-wrap connection press-in connection	x x x	x x x	x x x	x x x	x x x	x x x	x x x	x x x	
Insulating material	Glass-fiber reinforced thermoplastic material								
Contact surface	Au on Pd on Ni					Au on Ni	Au on Pd on Ni	Ag	
Insertion/removal cycles industria climate test	≥ 400 insertion/removal cycles, industrial climate to CECC 75101-801 (4 days SO ₂)							≥ 500 insertion/removal cycles (10 days SO ₂)	
High-current, coaxial and fiber-optic contacts	—		yes	—					
Approvals	UL listed: File E 92320, Project 84 ME 9787 CECC 75101-801								

*) Designs not listed in the SCS book are available upon request

Connectors PC 612

Blade-contact connectors in acc. with DIN 41 612, design B (double-row dielectric)

With angled solder pins or with straight solder pins (suitable for holes with $\varnothing 1 \text{ mm} \pm 0,1$)

2,54 mm center spacing

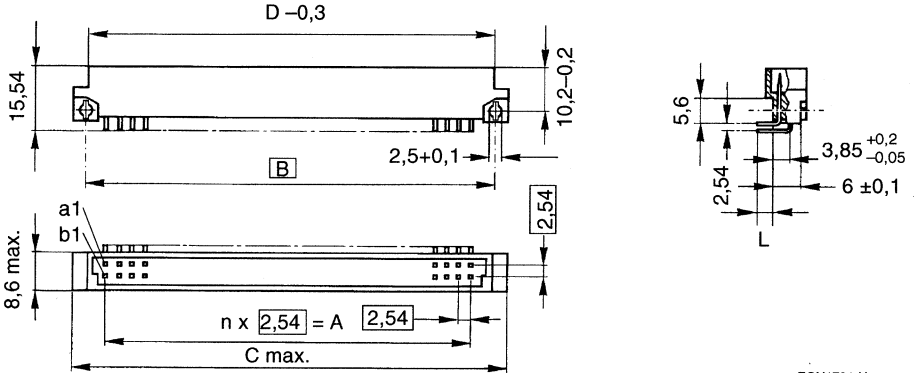

ECN1731-U

Design	n	Dimensions in mm							
		Blade-contact connector				Female connector			
		A	B	C	D	A	B	C	E
B	31	78,74	88,9	94	89	78,74	90	95	85
B/2	15	38,1	48,26	53,36	48,36	38,1	50	55	44,36

Number of contacts	Equipped contact rows	Performance level	Ordering code	DU						
			V42254-	Pcs						

Design B
with angled solder pins $L = 3 - 0,4 \text{ mm}$

Number of contacts	Equipped contact rows	Performance level	Ordering code	DU					
32	a	2	B1200-B641	40					
64	a b	2	B1200-B640	40					

with straight solder pins $L = 4,5 \pm 0,3 \text{ mm}$

Number of contacts	Equipped contact rows	Performance level	Ordering code	DU					
64	a b	2	B1202-B640	40					

Design B/2
with angled solder pins $L = 3 - 0,4 \text{ mm}$

Number of contacts	Equipped contact rows	Performance level	Ordering code	DU					
32	a b	2	B1200-B320	60					

Connectors PC 612

Female connectors in acc. with DIN 41 612, design B (double-row dielectric)

With straight solder pins (suitable for holes with $\varnothing 1 \text{ mm} \pm 0,1$)

or with wire-wrap pins ($0,6 \times 0,6 \text{ mm}$)

2,54 mm center spacing

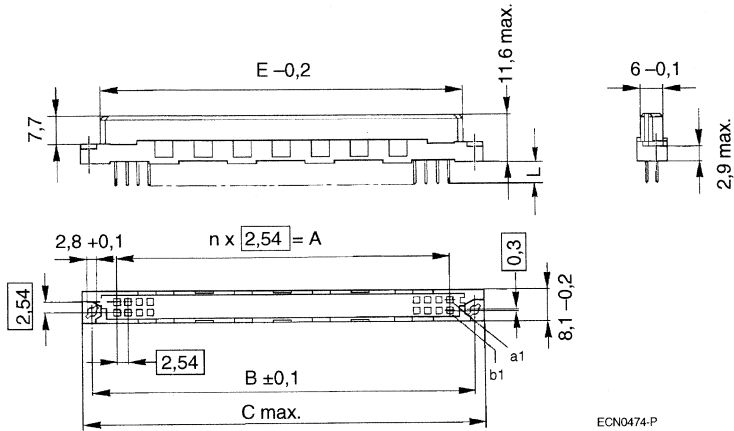

For dimensions see 124

Number of contacts	Equipped contact rows	Performance level	Ordering code	DU				
			V42254-	Pcs				

Design B

with solder pins $L = 2,9 \pm 0,3 \text{ mm}$

64	a b	2	B2201-B640	40				
----	-----	---	------------	----	--	--	--	--

with solder pins $L = 4,5 \pm 0,3 \text{ mm}$

32	a	2	B2202-B641	40				
64	a b	2	B2202-B640	40				

with wire-wrap pins $L = 13 + 0,5 \text{ mm}$

64	a b	2	B2240-B640	20				
----	-----	---	------------	----	--	--	--	--

Design B/2

with solder pins $L = 4,5 \pm 0,3 \text{ mm}$

32	a b	2	B2202-B320	60				
----	-----	---	------------	----	--	--	--	--

Connectors PC 612

Blade-contact connectors in acc. with DIN 41 612, design C (triple-row dielectric)

With angled solder pins or with straight solder pins (suitable for holes with $\varnothing 1 \text{ mm} \pm 0,1$)

2,54 mm center spacing

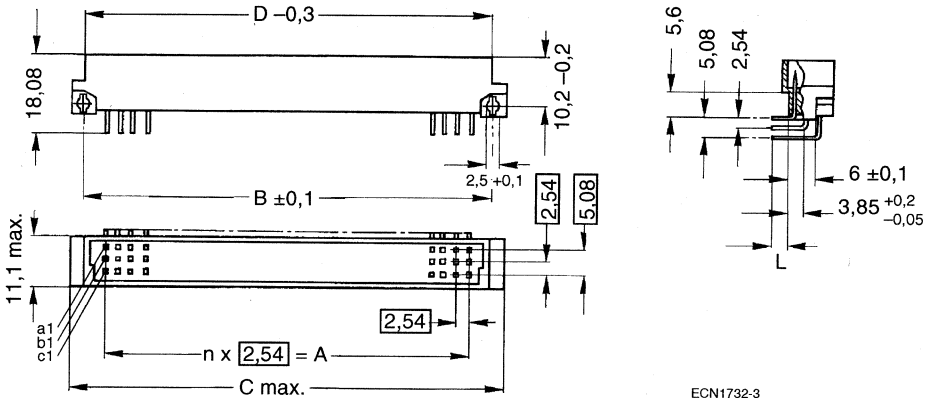

For dimensions see 124

Number of contacts	Equipped contact rows	Performance level	Ordering code	DU						
			V42254-	Pcs						

Design C
with angled solder pins $L = 3 - 0,4 \text{ mm}$

32	a c ¹⁾	2	B1200-C968	40						
64	a c	2	B1200-C963	40						
96	a b c	2	B1200-C960	40						

with straight solder pins $L = 4,5 \pm 0,3 \text{ mm}$

64	a c	2	B1202-C963	100						
96	a b c	2	B1202-C960	100						

Design C/2
with angled solder pins $L = 3 - 0,4 \text{ mm}$

32	a c	2	B1200-C483	60						
48	a b c	2	B1200-C480	60						

1) Component spacing 5,08 mm (a2, a4 ...)

Connectors PC 612

Female connectors in acc. with DIN 41 612, design C (triple-row dielectric)

With straight solder pins (suitable for holes with $\varnothing 1 \text{ mm} \pm 0,1$)

or with wire-wrap pins ($0,6 \times 0,6 \text{ mm}$)

or with press-in terminals (suitable for holes with $\varnothing 1 \text{ mm} + 0,9/- 0,6$)

2,54 mm center spacing

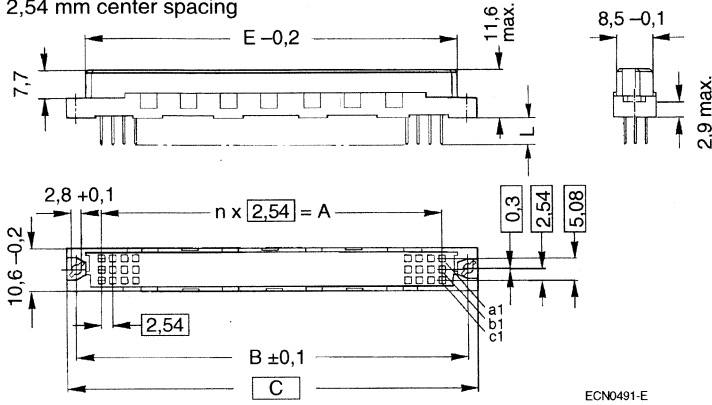

With soldering lugs

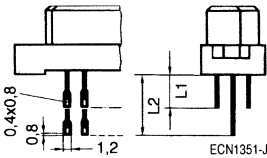

For dimensions see 124

Number of contacts	Equipped contact rows	Performance level	Ordering code	DU														
			V42254-	Pcs														

Design C
with solder pins $L = 2,9 \pm 0,3 \text{ mm}$

32	a c ¹⁾	2	B2201-C968	100														
64	a c	2	B2201-C963	100														
96	a b c	2	B2201-C960	100														

with solder pins $L = 4,5 \pm 0,3 \text{ mm}$

32	a c ¹⁾	2	B2202-C968	100														
64	a c	2	B2202-C963	100														
96	a b c	2	B2202-C960	100														

1) Component spacing 5,08 mm (a2, a4 ...)

Connectors PC 612

Number of contacts	Equipped contact rows	Performance level	Ordering code V42254-	DU Pcs											
Design C															
with wire-wrap pins L = 13 + 0,5 mm															
32	a c ¹⁾	2	B2240-C968	20											
64	a c	2	B2240-C963	20											
96	a b c	2	B2240-C960	20											
with press-in terminals L = 3,7 ± 0,3 mm															
64	a c	2	P2263-C963	100											
96	a b c	2	P2263-C960	100											
with soldering lugs															
32	a c ¹⁾	2	B2235-C968	40											
64	a c	2	B2235-C963	40											
96	a b c	2	B2235-C960	20											
Design C/2															
with solder pins L = 2,9 ± 0,3 mm															
48	a b c	2	B2201-C480	100											
with solder pins L = 4,5 ± 0,3 mm															
32	a c	2	B2202-C483	100											
48	a b c	2	B2202-C480	100											
with wire-wrap pins L = 13 + 0,5 mm															
48	a b c	2	B2240-C480	30											

1) Component spacing 5,08 mm (a2, a4 ...)

Connectors PC 612

Blade-contact connectors in acc. with DIN 41 612, design D (triple-row dielectric)

With angled solder pins (suitable for holes with $\varnothing 1 \text{ mm} \pm 0,1$)

For high voltages and high currents, e.g. for power supply units

5,08 mm center spacing

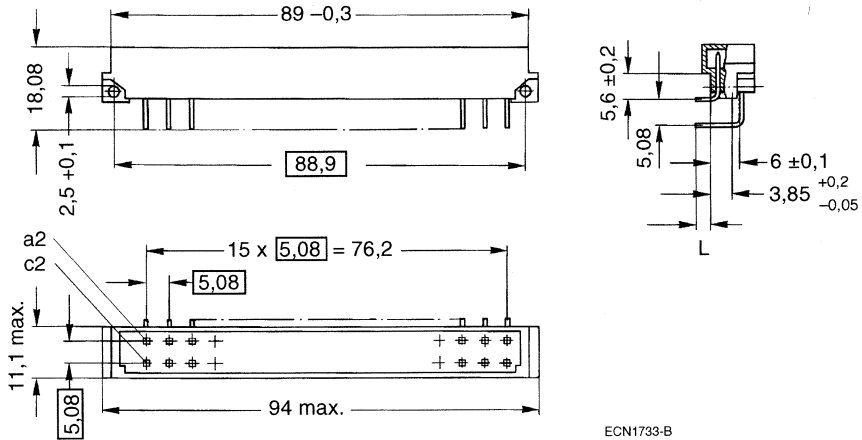

Number of contacts	Equipped contact rows	Performance level	Ordering code	DU						
32	a c	2	V42254- B1200-D325	Pcs 40						

Connectors

Connectors PC 612

Female connectors in acc. with DIN 41 612, design D (triple-row dielectric)

With straight solder pins (suitable for holes with $\varnothing 1 \text{ mm} \pm 0,1$)

For high voltages and high currents, e.g. for power supply units

5,08 mm center spacing

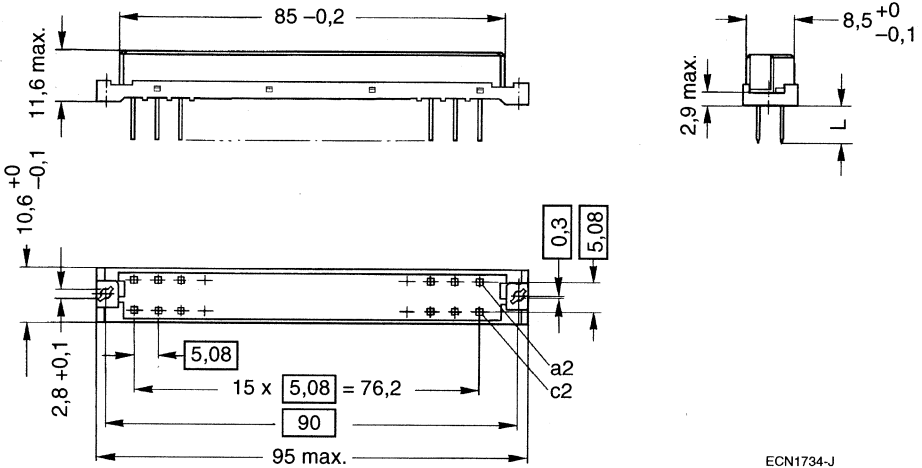

With soldering lugs

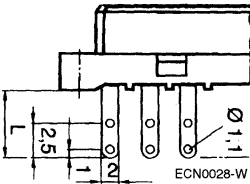

Number of contacts	Equipped contact rows	Performance level	Ordering code	DU				
			V42254-	Pcs				
with solder pins $L = 2,9 \pm 0,3 \text{ mm}$								
32	a c	2	B2501-D325	40				
with solder pins $L = 4,5 \pm 0,3 \text{ mm}$								
32	a c	2	B2502-D325	40				
with soldering lugs $L = 8 \pm 0,3 \text{ mm}$								
32	a c	2	B2535-D325	40				

Connectors PC 612

Blade-contact connectors in acc. with DIN 41 612, design F

With angled solder pins (suitable for holes with $\varnothing 1 \text{ mm} \pm 0,1$)

2,54 mm center spacing
(5,08 mm in longitudinal direction)

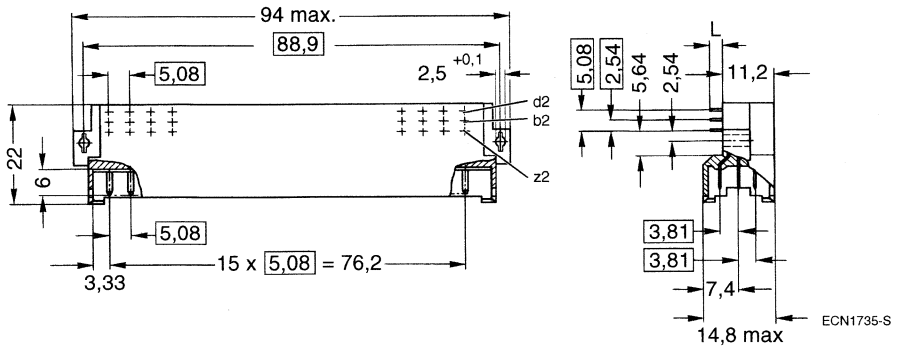

Number of contacts	Equipped contact rows	Performance level	Ordering code	DU											
			V23533-	Pcs											

with solder pins L = 3 – 0,4 mm

32	z b	2	B1200-F407	40											
32	z d	2	B1200-F408	40											
48	z b d	2	B1200-F405	40											

Connectors

Connectors PC 612

Female connectors in acc. with DIN 41 612, design F

With straight solder pins $\varnothing 0,8$ mm (suitable for holes with $\varnothing 1$ mm $\pm 0,1$)
 or with wire-wrap pins 1 mm \times 1 mm (suitable for holes with $\varnothing 1,6$ mm $\pm 0,1$)
 or with press-in terminals (suitable for holes with $\varnothing 1$ mm + 0,9/- 0,6)

5,08 center spacing

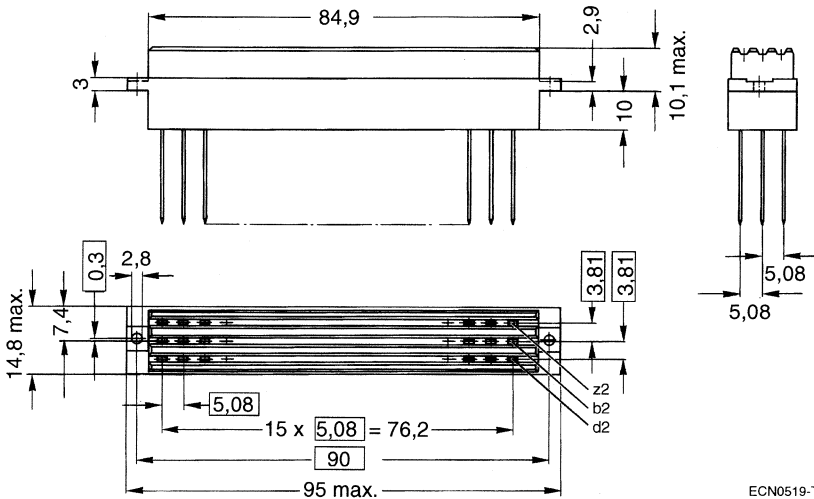

ECN0519-T

Number of contacts	Equipped contact rows	Performance level	Ordering code	DU				
			V23533-	Pcs				
with solder pins L = 3,2 \pm 0,3 mm								
32	z d	2	B2207-F408	40				
48	z b d	2	B2207-F405	40				
with wire-wrap pin L = 22 \pm 0,3 mm								
32	z b	2	B2251-F407	40				
32	z d	2	B2251-F408	20				
48	z b d	2	B2251-F405	20				
with press-in terminals L = 4 - 0,3 mm								
NEW	48	z b d	2	P2263-F405	20			

Connectors PC 612

Blade-contact connectors in acc. with DIN 41 612, design G

With angled solder pins (suitable for holes with $\varnothing 1 \text{ mm} \pm 0,1$)

2,54 mm center spacing

(pin assignment: row f in row z)

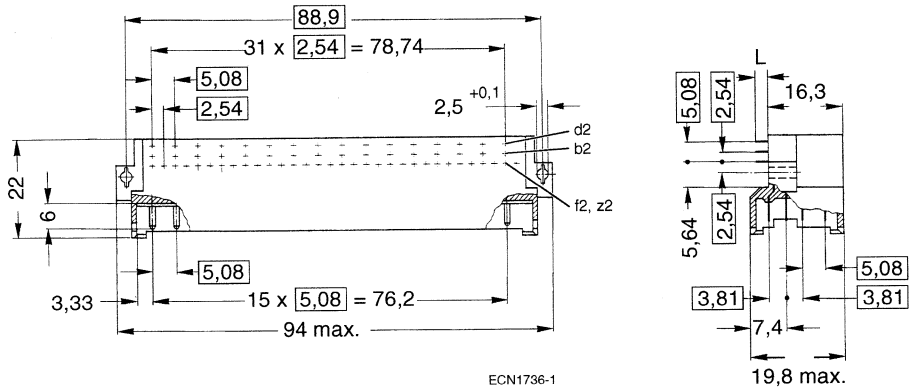

ECN1736-1

Number of contacts	Equipped contact rows	Performance level	Ordering code	DU						
			V23533-	DU Pcs						
with solder pins L = 3 – 0,4 mm										
64	z b d f	2	B1200-G605	30						

Connectors

Connectors PC 612

Female connectors in acc. with DIN 41 612, design G

With straight solder pins $\varnothing 0,8$ mm (suitable for holes with $\varnothing 1$ mm $\pm 0,1$)
 or with wire-wrap pins 1 mm $\times 1$ mm (suitable for holes with $\varnothing 1,6$ mm $\pm 0,1$)
 5,08 mm center spacing

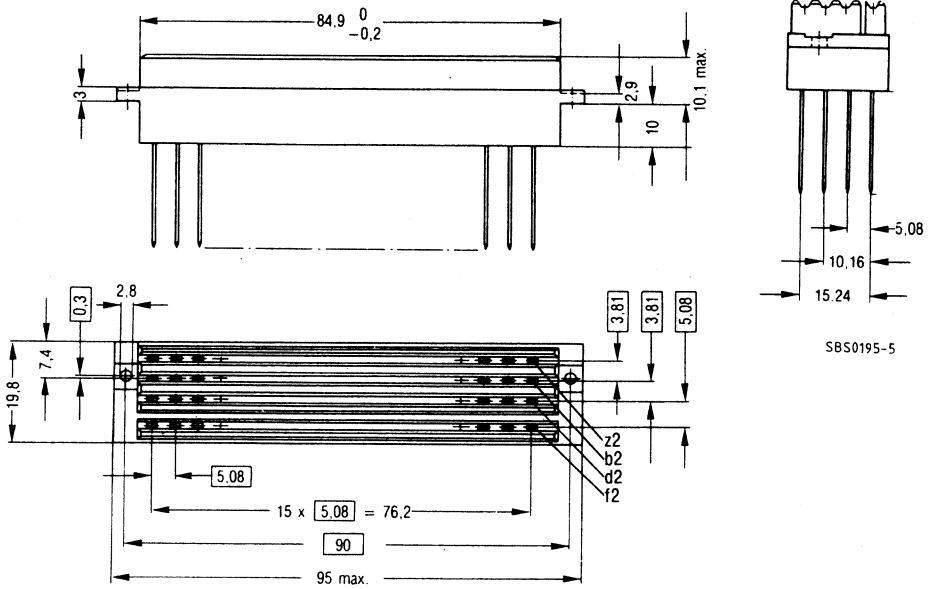

Number of contacts	Equipped contact rows	Performance level	Ordering code	DU							
			V23533-	Pcs							
with solder pins L = 3,2 \pm 0,3 mm											
64	z b d f	2	B2207-G605	30							
with wire-wrap pins L = 22 \pm 0,3 mm											
64	z b d f	2	B2251-G605	15							

Connectors PC 612

Blade-contact connectors in acc. with DIN 41612, design H (double-row dielectric)

With angled solder pins (suitable for holes with $\varnothing 1,6 \text{ mm} \pm 0,1$)

5,08 mm center spacing

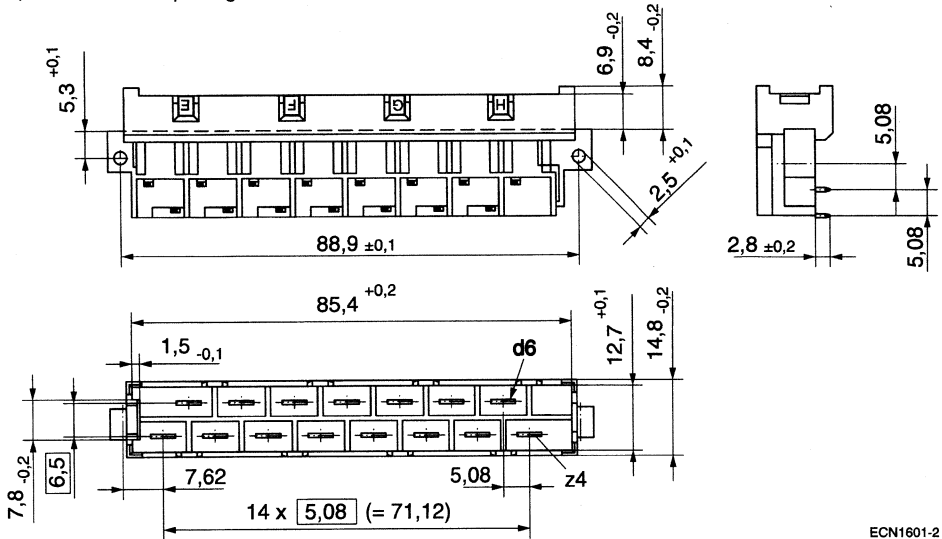

ECN1601-2

With quick connects (Faston)

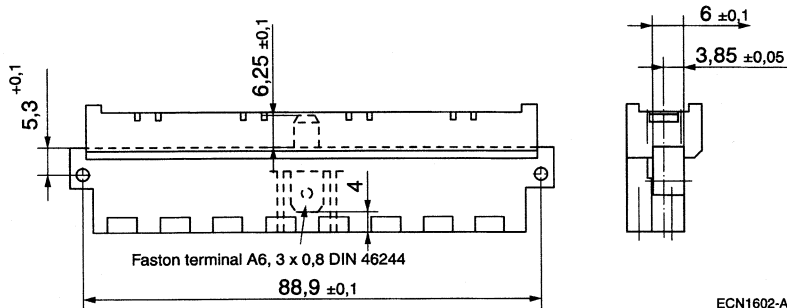

ECN1602-A

Number of contacts	Equipped contact rows	Performance level	Ordering code	DU Pcs					
			V23533-						
with angled solder pins L = 2,8 ± 0,2 mm									
15	z d	1	B1700-H105	22					
with quick connects A 6,3 × 0,8 DIN 46244									
15	z d	1	B1736-H105	22					

Connectors

Connectors PC 612

Female connectors in acc. with DIN 41 612, design H (double-row dielectric)

With straight solder pins (suitable for holes with $\varnothing 1 \text{ mm} \pm 0,1 / \varnothing 1,6 \text{ mm} \pm 0,1$)

Single terminals $1,2 \times 0,6 \text{ mm}$ (hole $\varnothing 1,6 \text{ mm} \pm 0,1$)

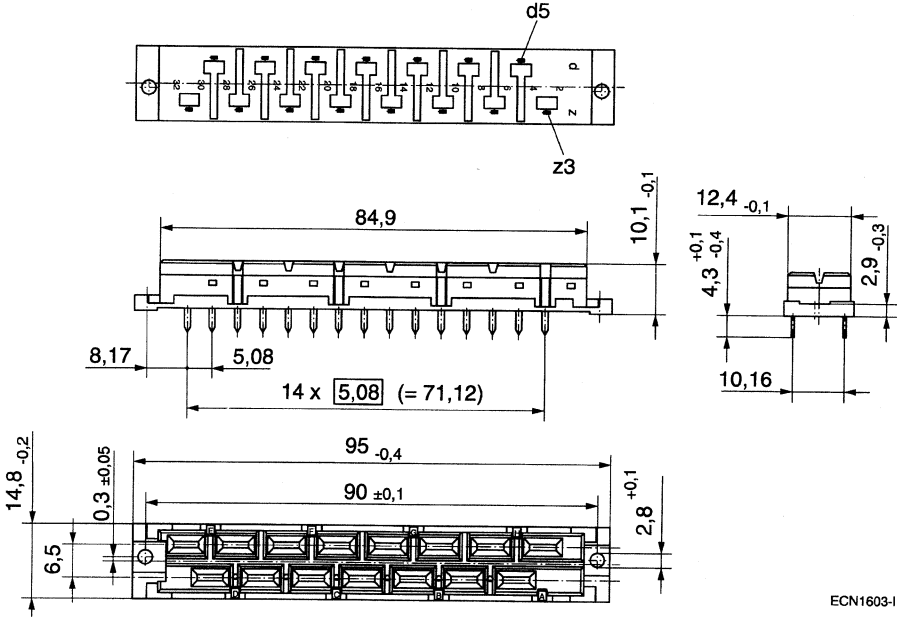

Double terminals $0,6 \times 0,6 \text{ mm}$ (hole $\varnothing 1 \text{ mm} \pm 0,1$)

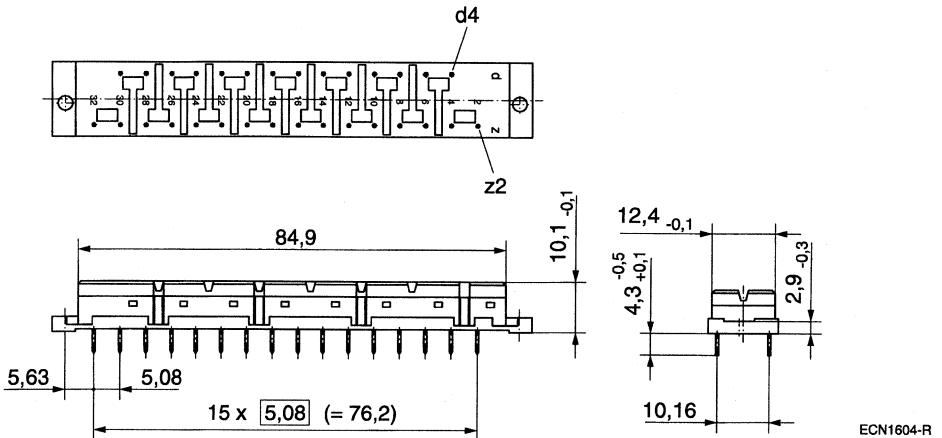

Connectors PC 612

With press-in terminals (suitable for holes with $\varnothing 1 \text{ mm} + 0,9/- 0,6$)

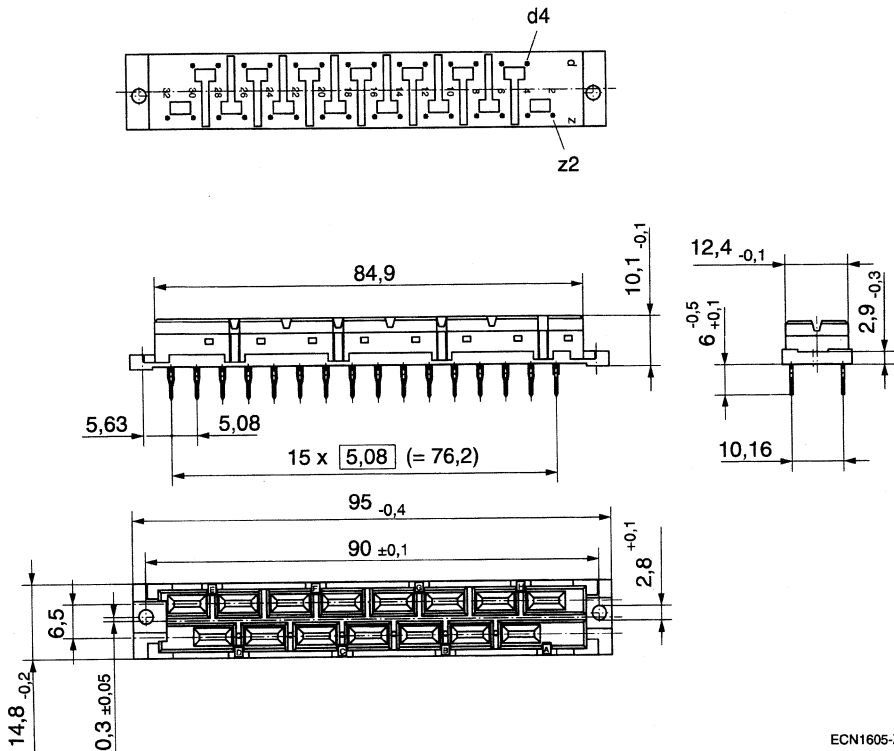

ECN1605-Z

Connectors

Number of contacts	Equipped contact rows	Performance level	Ordering code V23533-	DU Pcs					
with solder pins, single terminals, L = 4,3 + 0,1/- 0,4 mm									
15	z d	1	B2715-H105	44					
with solder pins, double terminals, L = 4,3 + 0,1/- 0,5 mm									
30	z d	1	B2702-H105	44					
with press-in terminals L = 6 + 0,1/- 0,5 mm									
30	z d	1	B2770-H105	44					

Connectors PC 612

Blade-contact connectors in acc. with DIN 41 612, design M (triple-row dielectric)

With angled solder pins (suitable for holes with $\varnothing 1 \text{ mm} \pm 0,1$)

For special contacts SK refer to page 143

2,54 mm center spacing

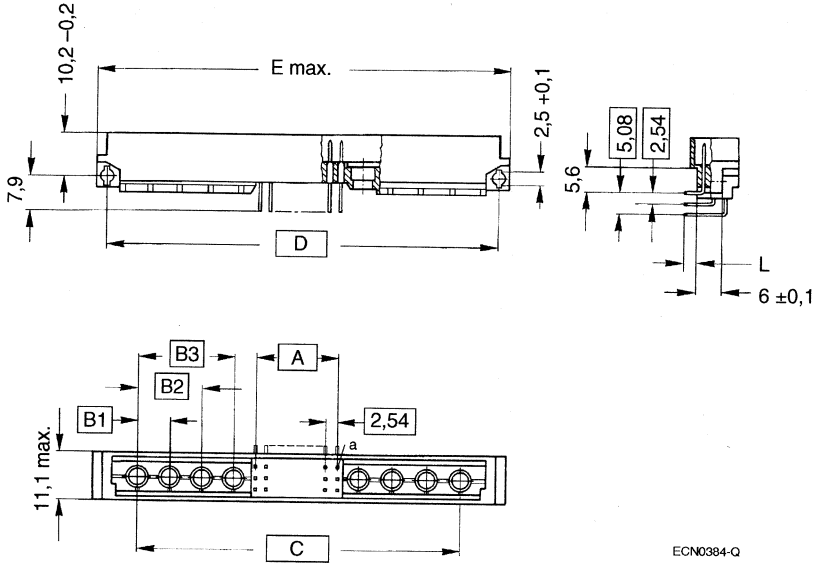

For dimensions see next page

Number of contacts	Equipped contact rows	Performance level	Ordering code	DU							
			V42254-	Pcs							

Design M
with angled solder pins $L = 3 - 0,4 \text{ mm}$

78+2SK	a b c	2	B1200-M780	40							
60+4SK	a b c	2	B1200-M600	40							
42+6SK	a b c	2	B1200-M420	40							

Design M/2
with angled solder pins $L = 3 - 0,4 \text{ mm}$

30+2SK	a b c	2	B1200-M300	60							
--------	-------	---	------------	----	--	--	--	--	--	--	--

Connectors PC 612

Female connectors in acc. with DIN 41 612, design M (triple-row dielectric)

With straight solder pins (suitable for holes with $\varnothing 1 \text{ mm} \pm 0,1$)

For special contacts SK refer to page 137

2,54 mm center spacing

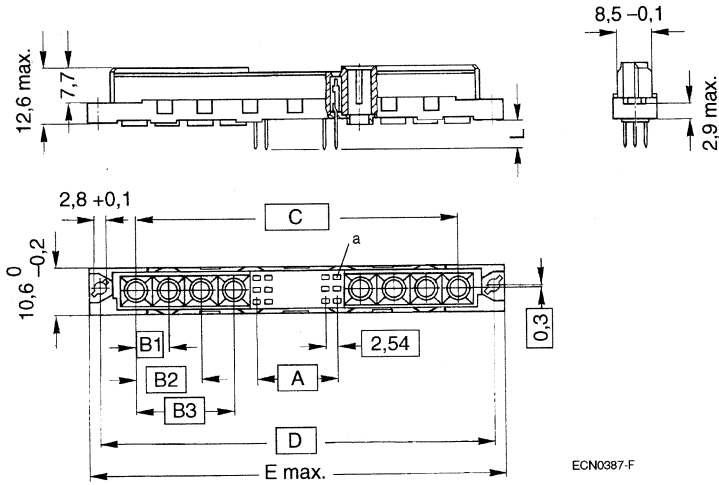

Connectors

Version	Number of contacts	Dimensions in mm					Blade-contact connector		Female connector		
		A	B ₁	B ₂	B ₃	C	D	E	D	E	
Design M		78+ max. 2 SK	25 × 2,54 = 63,5	-	-	-	73,66	88,9	94	90	95
		60+ max. 4 SK	19 × 2,54 = 48,26	3 × 2,54 = 7,62	-	-	73,66	88,9	94	90	95
		42+ max. 6 SK	13 × 2,54 = 33,02	3 × 2,54 = 7,62	6 × 2,54 = 15,24	-	73,66	88,9	94	90	95
Design M/2		30+ max. 2 SK	9 × 2,54 = 22,86	-	-	-	33,02	48,26	53,36	55	50

Connectors PC 612

Number of contacts	Equipped contact rows	Performance level	Ordering code	DU										
			V42254-	Pcs										

Design M
with solder pins L = 4,5 ± 0,3 mm

78+2SK	a b c	2	B2202-M780	100										
60+4SK	a b c	2	B2202-M600	100										
42+6SK	a b c	2	B2202-M420	100										

Design M/2
with solder pins L = 4,5 ± 0,3 mm

30+2SK	a b c	2	B2202-M300	100										
--------	-------	---	------------	-----	--	--	--	--	--	--	--	--	--	--

Connectors PC 612 Accessories

Special contacts (SK) for male and female connectors, design M

High-current connector for male connectors

Outline drawing 1

Plug for cable connection

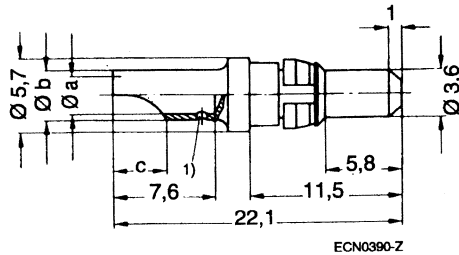

Outline drawing 2

Plug for PC board connection

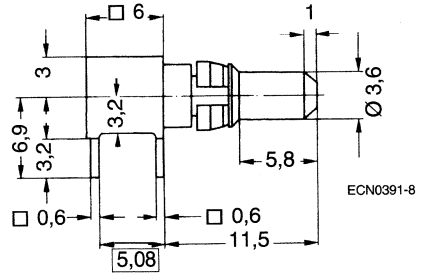

Pin arrangement for 2,54 grid

High-current connector for female connectors

Outline drawing 3

Socket for cable connection

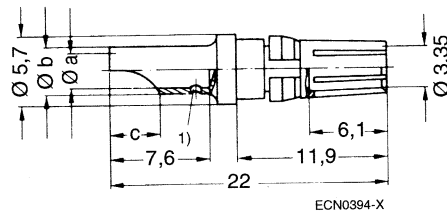

Rated current	Dimensions in mm		
	a \varnothing	b \varnothing	c
40 A	4,7	5,7	5
20 A	2,7	3,8	4
10 A	1,6	2,7	3

Outline drawing	Rated current	Ordering code	DU						
			Pcs						
		C42334-							
IEW 1	40 A	A347-A91 ²⁾	10						
1	20 A	A347-A92 ²⁾	10						
1	10 A	A347-A93 ²⁾	10						
IEW 2	25 A	A347-A102	10						
IEW 3	40 A	A347-A94 ²⁾	10						
3	20 A	A347-A95 ²⁾	10						
3	10 A	A347-A96 ²⁾	10						

1) Only at 10 A rated current
2) Also suitable for SIEDECON

Connectors PC 612

Accessories

Coaxial connectors series 1,0/2,3 (50 Ω and 75 Ω), with “snap-in” in accordance with DIN 41 626, part 2, for female connectors

Outline drawing 1

Bulkhead plug with cable connection,
Style A
(Inner conductor can be soldered through
soldering window)
for cables: Ø 2,6 RG 316 (50 Ω) and
Ø 2,67 RG 179 (75 Ω)

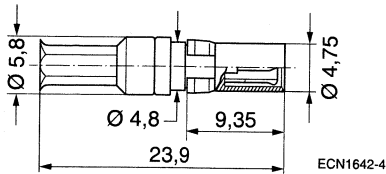

Outline drawing 2

Bulkhead plug with cable connection,
Style B
(Inner conductor can be
soldered separately)
for cables: Ø 2,6 RG 316 (50 Ω) and
Ø 2,67 RG 179 (75 Ω)

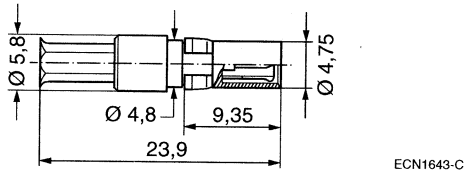

Outline drawing 3

Bulkhead plug with angle cable connection
Ø 2,6 RG 316 (50 Ω) and
Ø 2,67 RG 179 (75 Ω)

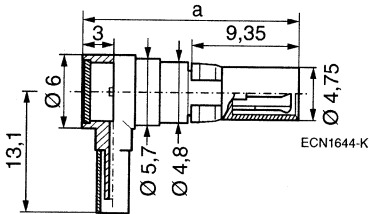

dimension a = 18,7 mm

Outline drawing 4

Bulkhead angle plug with PC board connection
for SIEDECON-FL

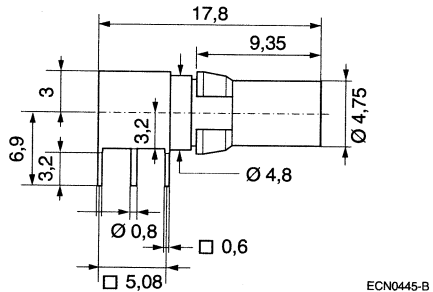

Pin arrangement for 2,54 grid

Outline drawing	Ordering code	DU						
		Pcs						
NEW 1	V23601-A302-E71 ¹⁾	25						
2	V23601-B302-E71 ¹⁾	25						
3	V23601-A502-E71 ¹⁾	25						
NEW 4	V23601-A1127-E1	100						

1) Also suitable for SIEDECON

Connectors PC 612 Accessories

Coaxial connectors series 1,0/2,3 (50 Ω and 75 Ω), with “snap-in” in accordance with DIN 41 626, part 2, for female connectors

Bulkhead plug with PC board connections

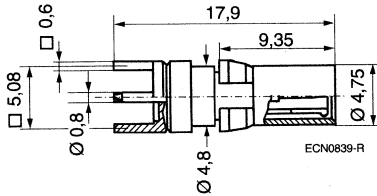

Pin arrangement
for 2,54 mm grid

Outline drawing	Ordering code	DU						
		Pcs						
IEW -	V23601-A927-E1	20						

Connectors

Connectors PC 612 Accessories

Coaxial connectors series 1,0/2,3 (50 Ω and 75 Ω), with “snap-in” in accordance with DIN 41 626, part 2, for male connectors

Outline drawing 1

Bulkhead jack with cable connection,
Style A
(Inner conductor can be soldered through
soldering window)
for cables: Ø 2,6 RG 316 (50 Ω) and
Ø 2,67 RG 179 (75 Ω)

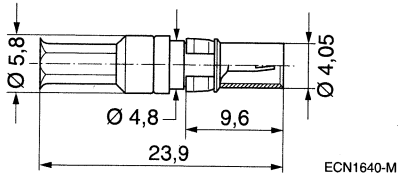

Outline drawing 2

Bulkhead jack with cable connection,
Style B
(Inner conductor can be
soldered separately)
for cables: Ø 2,6 RG 316 (50 Ω) and
Ø 2,67 RG 179 (75 Ω)

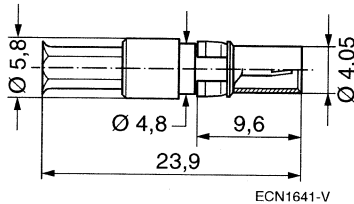

Outline drawing 3

Bulkhead jack with angle
cable connection
for cables: Ø 2,6 RG 316 (50 Ω) and
Ø 2,67 RG 179 (75 Ω)

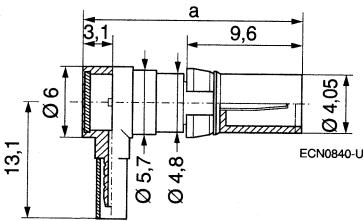

dimension a = 24 mm

Outline drawing 4

Bulkhead angle jack
with PC board connection

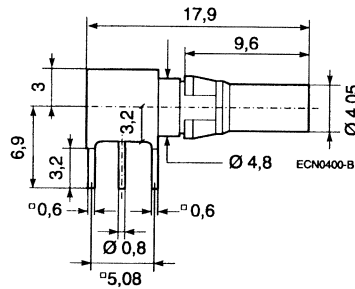

Pin arrangement for 2,54 mm grid

	Outline drawing	Ordering code	DU				
			Pcs				
NEW	1	V23601-A602-E71 ¹⁾	25				
	2	V23601-B602-E71 ¹⁾	25				
NEW	3	V23615-B856-E57 ¹⁾	25				
	4	V23601-A1227-E1	100				

1) Also suitable for SIEDECON

Connectors PC 612

Blade-contact connectors in acc. with DIN 41 612, design Q (triple-row dielectric)
 Inverted version of design B

With straight solder pins (suitable for holes with $\varnothing 1 \text{ mm} \pm 0,1$)

2,54 mm center spacing

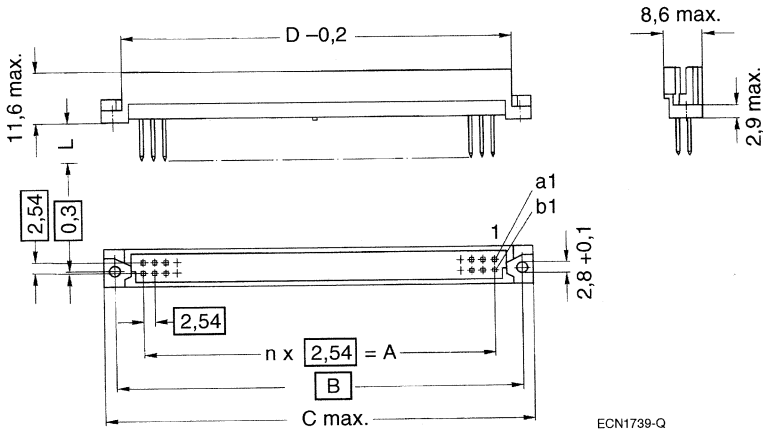

Design	n	Dimensions in mm			
		A	B	C	D
Q	31	78,74	90	95	88
Q/2	15	38,1	50	55	47,6

Number of contacts	Equipped contact rows	Performance level	Ordering code	DU																
			V42254-	Pcs																

Design Q
 with solder pins $L = 4,5 \pm 0,3 \text{ mm}$

64	a b	2	B1202-Q640	40																
----	-----	---	------------	----	--	--	--	--	--	--	--	--	--	--	--	--	--	--	--	--

Design Q/2
 with solder pins $L = 4,5 \pm 0,3 \text{ mm}$

32	a b	2	B1202-Q320	60																
----	-----	---	------------	----	--	--	--	--	--	--	--	--	--	--	--	--	--	--	--	--

Connectors PC 612

Female connectors in acc. with DIN 41 612, design Q (triple-row dielectric)
 Inverted versions of design B

With angled solder pins (suitable for holes with $\varnothing 1 \text{ mm} \pm 0,1$)

2,54 mm center spacing

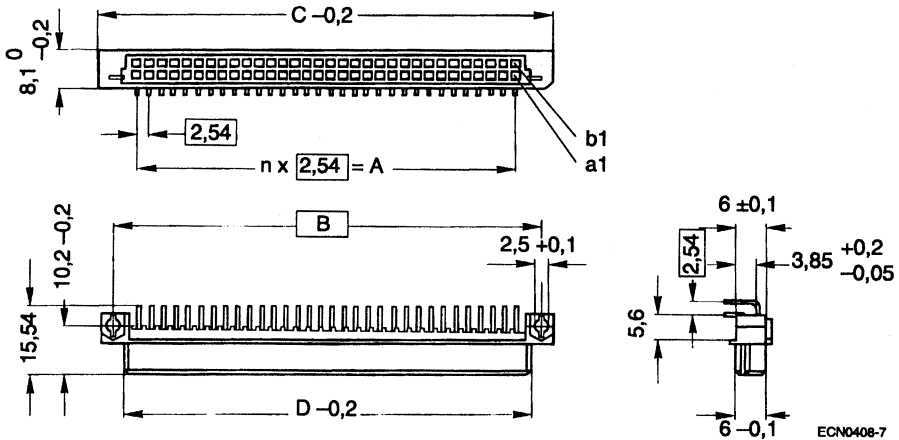

Design	Dimensions in mm				
	n	A	B	C	D
Q	31	78,74	88,9	94	85
Q/2	15	38,1	48,26	53,36	44,4

Number of contacts	Equipped contact rows	Performance level	Ordering code	DU Pcs					
			V42254-						

Design Q
 with angled solder pins $L = 3 - 0,4 \text{ mm}$

64	a b	2	B2200-Q640	40					
----	-----	---	------------	----	--	--	--	--	--

Design Q/2
 with angled solder pins $L = 3 - 0,4 \text{ mm}$

32	a b	2	B2200-Q320	60					
----	-----	---	------------	----	--	--	--	--	--

Connectors PC 612

Blade-contact connectors in acc. with DIN 41 612, design R (triple-row dielectric)
 Inverted version of design C

With straight solder pins (suitable for holes with $\varnothing 1 \text{ mm} \pm 0,1$)

2,54 mm center spacing

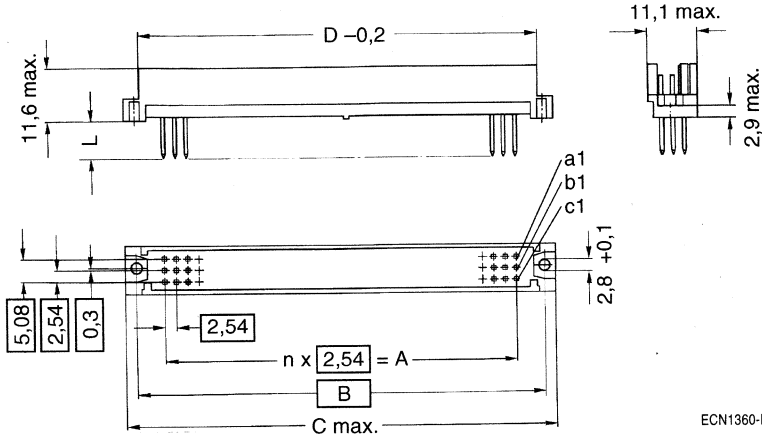

ECN1360-I

Design	n	Dimensions in mm			
		A	B	C	D
R	31	78,74	90	95	88
R/2	15	38,1	50	55	47,6

Number of contacts	Equipped contact rows	Performance level	Ordering code	DU						
			V42254-	Pcs						

Design R
 with solder pins $L = 2,9 \pm 0,3 \text{ mm}$

64	a c	2	B1201-R963	100						
96	a b c	2	B1201-R960	100						

with solder pins $L = 4,5 \pm 0,3 \text{ mm}$

64	a c	2	B1202-R963	100						
96	a b c	2	B1202-R960	100						

Design R/2
 with solder pins $L = 2,9 \pm 0,3 \text{ mm}$

48	a b c	2	B1201-R480	60						
----	-------	---	------------	----	--	--	--	--	--	--

with solder pins $L = 4,5 \pm 0,3 \text{ mm}$

32	a c	2	B1202-R483	60						
48	a b c	2	B1202-R480	60						

Connectors

Connectors PC 612

Female connectors in acc. with DIN 41 612, design R (triple-row dielectric)
 Inverted versions of design C

With angled solder pins (suitable for holes with $\varnothing 1 \text{ mm} \pm 0,1$)

2,54 mm center spacing

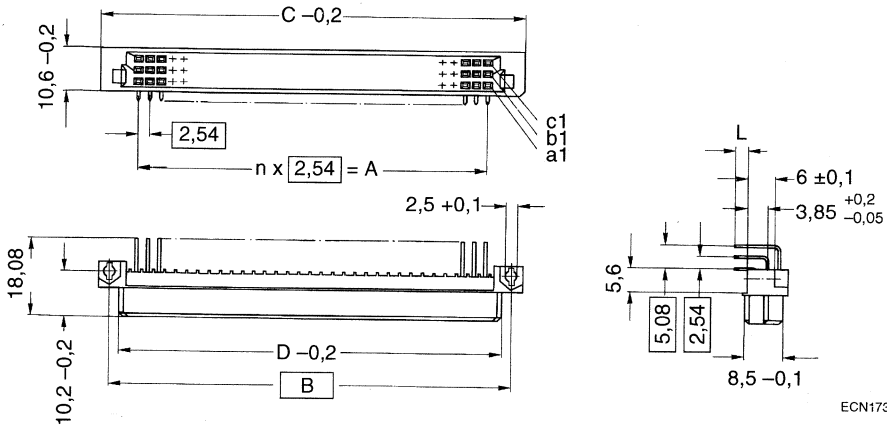

ECN1737-9

Design	n	Dimensions in mm			
		A	B	C	D
R	31	78,74	88,9	94	85
R/2	15	38,1	48,26	53,36	44,4

Number of contacts	Equipped contact rows	Performance level	Ordering code	DU																
			V42254-	Pcs																

Design R
 with angled solder pins $L = 3 - 0,4 \text{ mm}$

64	a c	2	B2200-R963	40																
96	a b c	2	B2200-R960	40																

Design R/2
 with angled solder pins $L = 3 - 0,4 \text{ mm}$

32	a c	2	B2200-R483	60																
48	a b c	2	B2200-R480	60																

Connectors PC 612

Accessories

Housings for blade-contact and female connectors

- For installation of female connectors in design C, D, M and blade-contact connectors in design R.
- Two cable inlets max. \varnothing 11 mm.
- Pull-relief facility incorporating cable strip at each cable inlet.

Material

- Polycarbonate, glass-fiber reinforced, pebble grey RAL 7032
- Ambient temperature range - 55 °C ... + 100 °C

- ⑥ 2 machine screws
M 2,5 × 12 DIN 84
- ⑦ 4 hexagon nuts
M 2,5 DIN 439
- ⑧ 2 washers
2,7 DIN 433
- ⑨ 2 machine screws
M 2,5 × 16 DIN 84

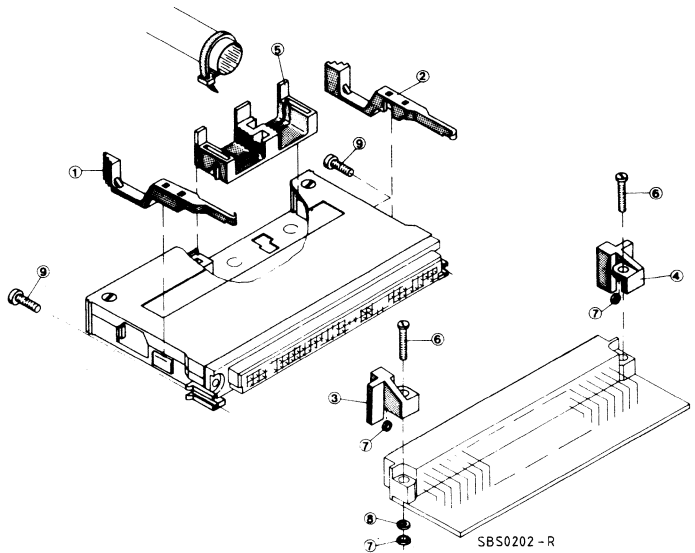

Connectors

Housing (set of parts, not assembled) for:	Ordering code C42334-	DU Pcs					
Female connectors, design B and blade-contact connectors, design Q	Z61-C1	10					
Female connectors, design C, D, M and blade-contact connectors, design R	Z61-C2	10					

Accessories

Item		Ordering code C42334-	DU Pcs				
①	Locking lever, left	Z61-C11	10				
②	Locking lever, right	Z61-C12	10				
③	Latching element, left	Z61-C14	10				
④	Latching element, right	Z61-C15	10				
⑤	Circular section cable insert	Z61-C16	10				

Required screws, washers und nuts commercially available

Insulation-Displacement Connectors for Ribbon Cables BK-DIL 368

Dual-in-line connector BK-DIL 368

14, 16, 18, 24 and 40 contacts

For permanent installation or for plugged connections in conjunction with socket BK-DIL 390.
2,54 mm center spacing

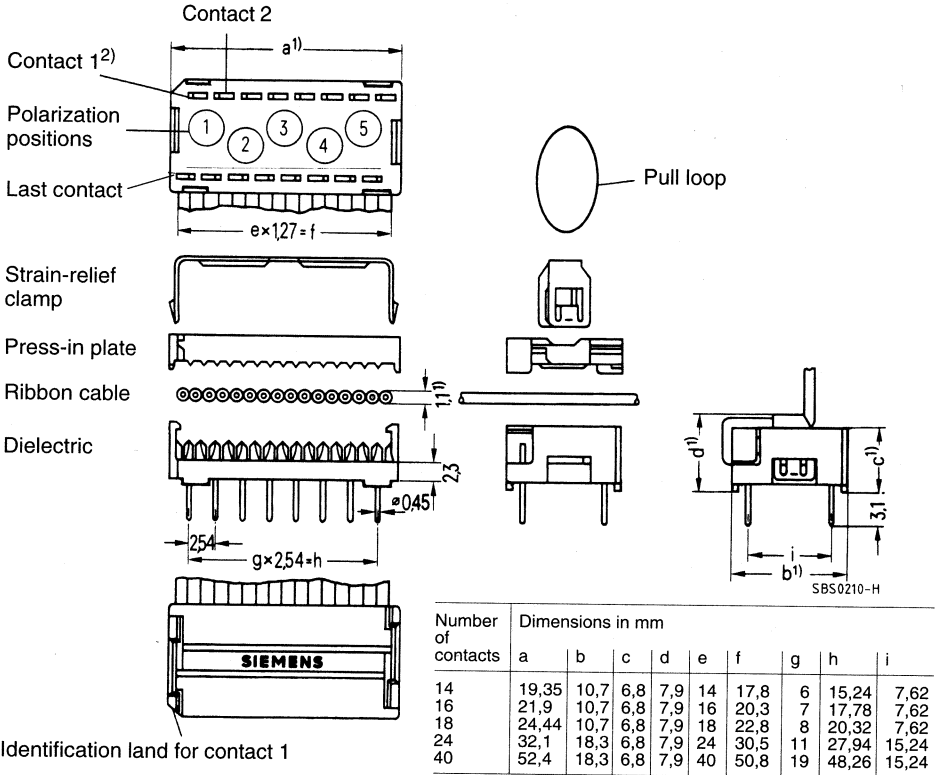

Version

- Suitable for the following cable cross-sections in acc. with DIN/VDE 0811:
 - stranded wire 0,09 mm² (AWG 28/7) only with strain-relief clamp and 0,14 mm² (AWG 26/7);
 - solid wire 0,25 mm Ø (AWG 30/1) and 0,32 mm Ø (AWG 28/1);
 - center spacing: 1,27 mm; insulation thickness: max. 1,27 mm

Technical data

Dielectric	thermoplastic material, glass-fiber reinforced
Contact material	copper alloy
Contact surface	insertion area: gold on nickel; soldering area: tin on nickel; insulation displacement terminal: tin on nickel

1) Max. dimension
2) Contact 1 is not identical to the conductor number of the ribbon cable.

Insulation-Displacement Connectors for Ribbon Cables BK-DIL 368

Current rating per contact at 20°C/70°C/100°C	2 A/1 A/0,5 A
Test voltage	0,5 kV
Insulation resistance	≥ 10 ⁵ MΩ
Flammability	in compliance with UL 94 V-1
Temperature range	- 55°C ... + 125°C
Connection frequency	performance level 3 ≥ 50 insertion/removal cycles
Approvals	UL E 92320 VOL 1 SEC3

Assignment information (View onto insulation-displacement terminal contacts)

Identification land

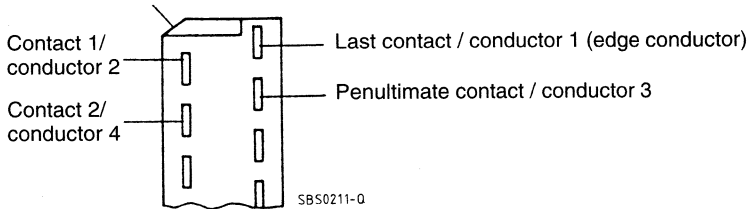

For the assembly of the connectors with ribbon cables tools are available for single-item production as well as for quantity production. Available on request.

Number of contacts	Ordering code	DU							
		Pcs							

BK-DIL connector, plug-in (nickel and hard-gold-plated pins)

14	C42334-A368-A14	60							
16	C42334-A368-A16	60							
18	C42334-A368-A18	60							
24	C42334-A368-A24	30							
40	C42334-A368-A40	30							

BK-DIL connector, solderable (nickel and tin-plated pins)

14	C42334-A368-A15	60							
16	C42334-A368-A17	60							

Strain-relief clamp

14	C42334-A368-C4	60							
16	C42334-A368-C5	60							
18	C42334-A368-C9	60							
24	C42334-A368-C6	30							
40	C42334-A368-C7	30							

Pull loop for plug-in connectors

14 u.16	C42334-A368-C8	60							
---------	----------------	----	--	--	--	--	--	--	--

Insulation-Displacement Connectors for Ribbon Cables BK-DIL 390

Dual-in-line socket BK-DIL 390

14, 16, 18, 24 and 40 contacts

For printed circuits

2,54 mm pin center spacing

Socket for connector BK-DIL 368

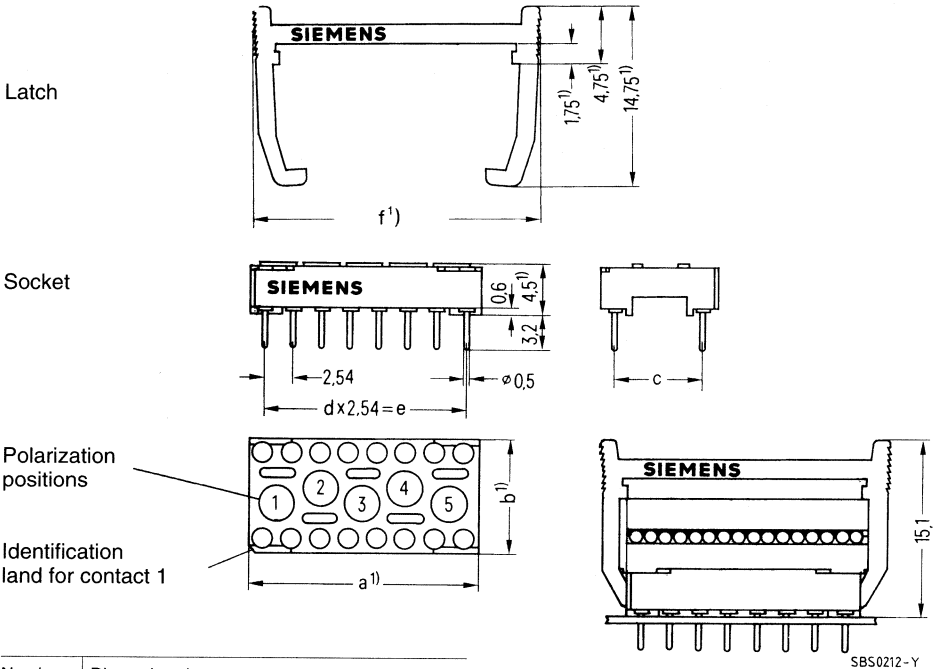

Number of contacts	Dimensions in mm					
	a	b	c	d	e	f
14	17,8	10,15	7,62	6	15,24	22,5
16	20,3	10,15	7,62	7	17,78	25,1
18	22,85	10,15	7,62	8	20,32	27,6
24	30,5	17,8	15,24	11	27,94	35,3
40	50,8	17,8	15,24	19	48,26	55,6

Version

- Precision circular contacts with gold-plated internal spring for contact pins with a diameter 0,4 to 0,55 mm or a diagonal dimension of 0,4 to 0,65 mm
- Identification land (bevel) for identifying the first contact
- Polarizing stud with insertion sleeve for polarizing between plug BK-DIL 368 and socket BK-DIL 390
- Latch to prevent disconnection and to assist removal

1) Max. dimension

Insulation-Displacement Connectors for Ribbon Cables BK-DIL 390

Technical data

Dielectric thermoplastic material, glass-fiber reinforced
 Contact material copper alloy
 Contact surface insertion area: gold on nickel
 soldering area: tin on nickel

Current rating per contact 2 A/1 A/0,5 A
 at 20 °C/70 °C/100 °C
 Contact resistance $\leq 20 \text{ m}\Omega$
 Test voltage 0,5 kV
 Insulation resistance $\geq 10^5 \text{ M}\Omega$
 Flammability in compliance with UL 94 V-1
 Temperature range $- 55^\circ\text{C} \dots + 125^\circ\text{C}$
 Connection frequency performance level 3 ≥ 50 insertion/removal cycles
 Approvals UL E 92320

For the assembly of the connectors with ribbon cables tools are available for single-item production as well as for quantity production. Available on request.

Number of contacts	Ordering code	DU							
		Pcs							

BK-DIL socket

14	C42334-A390-A14	100								
16	C42334-A390-A16	100								
18	C42334-A390-A18	100								
24	C42334-A390-A24	60								
40	C42334-A390-A40	60								

Latch

14	C42334-A390-C114	100								
16	C42334-A390-C116	100								
18	C42334-A390-C118	100								
24	C42334-A390-C124	60								
40	C42334-A390-C140	60								

Polarizing stud

for all versions	C42334-A390-C2	100								
------------------	----------------	-----	--	--	--	--	--	--	--	--

Insulation-Displacement Connectors for Ribbon Cables BK-LEV 413

PCB-connector BK-LEV 413

6, 10, 14, 16, 20, 26, 32, 34, 40, 50, 60 and 64 contacts
For printed circuits, 2,54 mm center spacing
Can be used as center or terminal connector

Strain-relief clamp

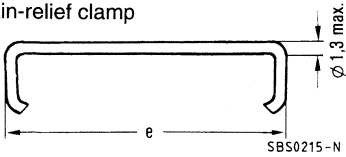

SBS0215-N

Contact for edge conductor

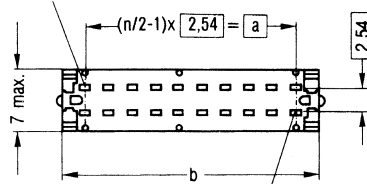

Contact for edge conductor

6,05 max. without strain-relief clamp

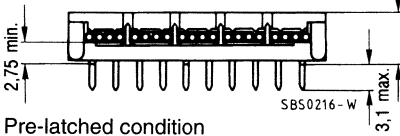

Pre-latched condition

Can be hinged on both sides

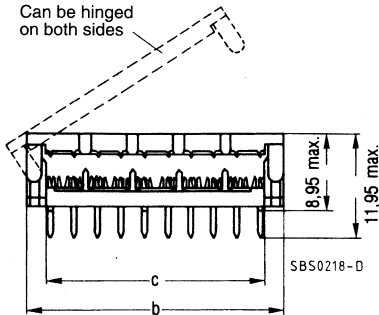

SBS0218-D

Number of contacts = n	Dimensions in mm			
	a	b max.	c min.	e max.
6	5,08	11,92	7,22	13,0
10	10,16	17,00	12,30	18,1
14	15,24	22,08	17,38	23,2
16	17,78	24,64	19,92	25,7
20	22,86	29,70	25,00	30,8
26	30,48	37,32	32,62	38,4
32	38,10	44,94	40,24	46,0
34	40,64	47,48	42,78	48,6
40	48,26	55,10	50,40	56,2
50	60,96	67,80	63,10	68,9
60	73,66	80,50	75,80	81,6
64	78,74	85,58	80,88	86,7

With strain-relief clamp

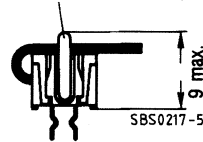

SBS0217-5

Assignment information

(View onto insulation-displacement terminal contacts)

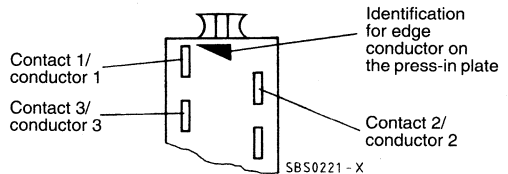

SBS0221-X

Version

- Suitable for cable cross-sections in acc. with DIN/VDE 0811: stranded wire 0,09 mm² (AWG 28/7) and 0,14 mm² (AWG 26/7). Solid wire 0,25 mm Ø (AWG 30/1) and 0,32 mm Ø (AWG 28/1) center spacing: 1,27 mm; insulation thickness: max. 1,1 mm
- Dielectric: pre-latching of press-in plate and body
- Integrated strain relief (patented)
- Additional strain relief by clamp
- Kinked solder pins
- Processing with automatic connector feed possible

Insulation-Displacement Connectors for Ribbon Cables BK-LEV 413

Technical data

Dielectric	thermoplastic material, glass-fiber reinforced
Contact material	copper alloy
Contact surface	insulation-displacement terminal: tin on nickel; solder pin: tin on nickel

Current rating per contact at 20 °C/70 °C/100 °C	2 A/1 A/0,5 A
Test voltage	0,5 kV
Insulation resistance	≥ 10 ⁵ MΩ
Flammability	complying with UL 94 V-0
Temperature range	- 55 °C ... + 125 °C
Approvals	UL E 92320

For the assembly of the connectors with ribbon cables tools are available for single-item production as well as for quantity production. Available on request.

Number of contacts	Ordering code	DU				
		Pcs				

PCB connector

6	V23535-B1780-C60	100					
10	V23535-B1780-C100	100					
14	V23535-B1780-C140	100					
16	V23535-B1780-C160	100					
20	V23535-B1780-C200	100					
26	V23535-B1780-C260	100					
32	V23535-B1780-C320	100					
34	V23535-B1780-C340	100					
40	V23535-B1780-C400	100					
50	V23535-B1780-C500	100					
60	V23535-B1780-C600	100					
64	V23535-B1780-C640	100					

Strain-relief clamp

6	C42334-A386-C59	100					
10	C42334-A386-C61	100					
14	C42334-A386-C63	100					
16	C42334-A386-C64	100					
20	C42334-A386-C66	100					
26	C42334-A386-C69	100					
32	C42334-A386-C72	100					
34	C42334-A386-C73	100					
40	C42334-A386-C76	100					
50	C42334-A386-C81	100					
60	C42334-A386-C86	100					
64	C42334-A386-C88	100					

Insulation-Displacement Connectors for Ribbon Cables BK-DIN 389

Female connector BK-DIN 389

Connection conditions in acc. with DIN 41612 , design B;
20, 32 and 64 contacts
Can be used as center and terminal connector.

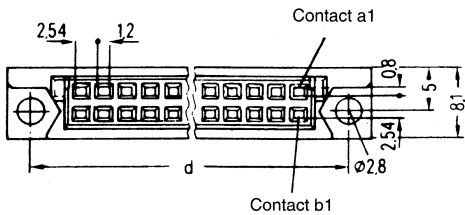
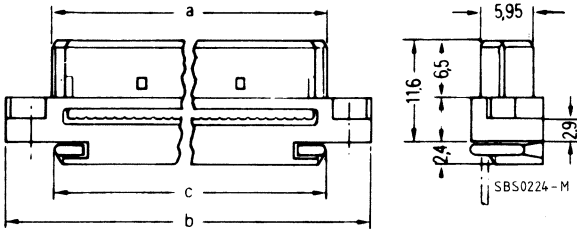

Design	Number of contacts	Dimensions in mm			
		a	b	c	d
B/3	20	29,2	39,76	28,90	34,76
B/2	32	44,4	55	44,16	50
B	64	85	95	84,80	90

Version

- Suitable for cable cross sections in acc. with DIN/VDE 0811:
stranded wire 0,09 mm² (AWG 28/7) only with strain-relief clamp and 0,14 mm² (AWG 26/7);
solid wire 0,25 mm Ø (AWG 30/1) and 0,32 mm Ø (AWG 28/1);
center spacing: 1,27 mm; insulation thickness: max. 1,27 mm
- Pre-latching of press-in plate and dielectric by double snap-in stage

Technical data

Dielectric thermoplastic material, glass-fiber reinforced
Contact material copper alloy
Contact surface insertion area: gold on nickel
insulation-displacement terminal: tin on nickel

Current rating per contact 2 A/1 A/0,5 A
at 20 °C/70 °C/100 °C
Test voltage 0,5 kV
Insulation resistance $\geq 10^5$ MΩ
Flammability in compliance with UL 94 V-1
Temperature range - 55 °C ... + 125 °C
Connection frequency performance level 3 ≥ 50 insertion/removal cycles

Insulation-Displacement Connectors for Ribbon Cables BK-DIN 389

Assignment information (view onto insertion side, pin layout)

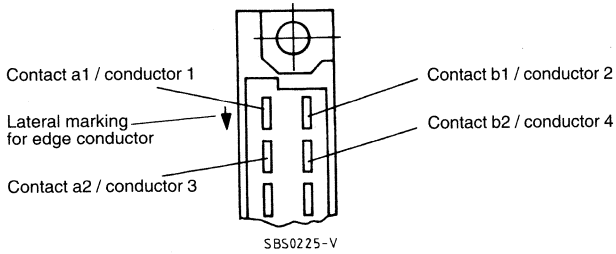

For the assembly of the connectors with ribbon cables tools are available for single-item production as well as for quantity production. Available on request.

Number of contacts	Ordering code	DU										
		Pcs										
Modular female connector												
20	C42334-A389-A20	80										
32	C42334-A389-A32	60										
64	C42334-A389-A64	40										
Strain-relief clamp												
20	C42334-A389-C120	80										
32	C42334-A389-C132	60										
64	C42334-A389-C164	40										

Connectors

Insulation-Displacement Connectors for Ribbon Cables BK-MOD 421/422

Modular grid connector BK-MOD 421/422

Pin and female connectors in acc. with DIN 41651
6, 10, 14, 16, 20, 26, 34, 40, 50, 60 and 64 contacts

Pin connectors BK-MOD 421 (standard and compact headers) for mating with female connectors BK-MOD 422. For terminal and bus connections.

Standard header (pin connector)

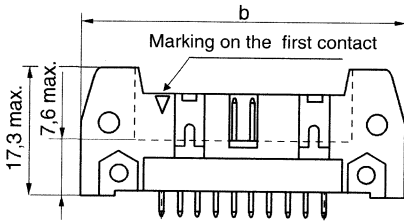

Straight tails
(vertical version)

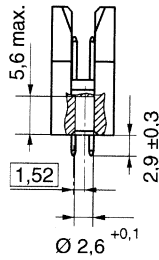

Angled tails
(horizontal version)

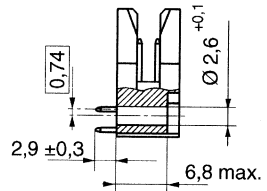

SBS0227-C

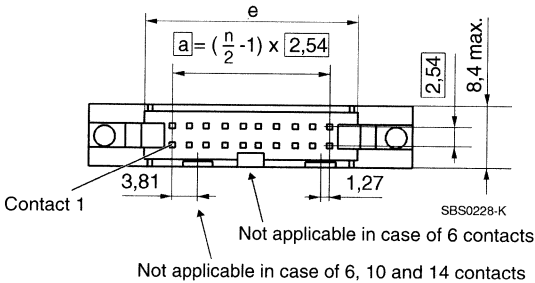

Number of contacts	Dimensions in mm		
	a	b max.	e min.
6	5,08	27,08	12,45
10	10,16	32,16	17,53
14	15,24	37,24	22,61
16	17,78	39,78	25,15
20	22,86	44,86	30,23
26	30,48	52,48	37,85
34	40,64	62,64	48,01
40	48,26	70,26	55,63
50	60,96	82,96	68,33
60	73,66	95,66	81,03
64	78,74	100,74	86,11

Locking facilities (with ejection function)

Locking hook, short,
for female connector without strain-relief clamp

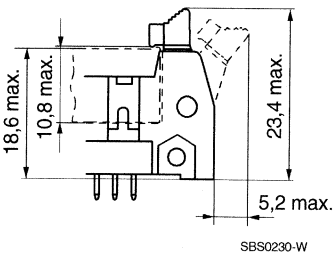

Locking hook, long,
for female connector with strain-relief clamp

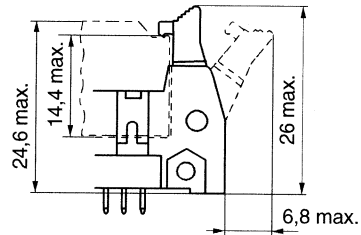

Insulation-Displacement Connectors for Ribbon Cables BK-MOD 421/422

Compact header (pin connector)

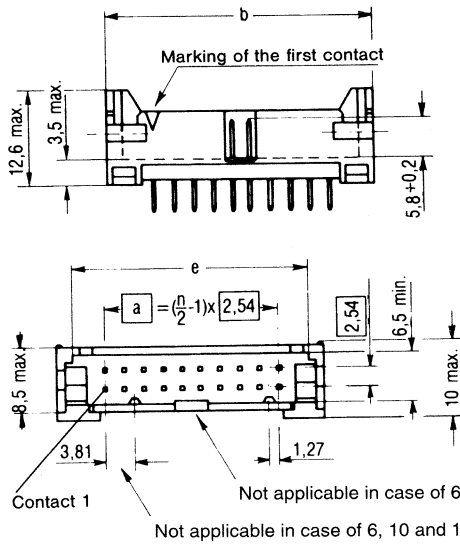

Straight tails
(vertical version)

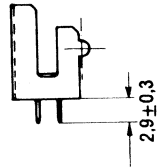

Angled tails
(horizontal version)

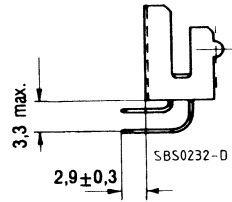

Number of contacts	Dimensions in mm		
	a	b max.	e min.
6	5,08	16,92	12,72
10	10,16	22,00	17,80
14	15,24	27,08	22,88
16	17,78	29,62	25,42
20	22,86	34,70	30,50
26	30,48	42,32	38,12
34	40,64	52,48	48,28

Locking facilities (with ejection function)

Locking hook, short, for female connector without strain-relief clamp

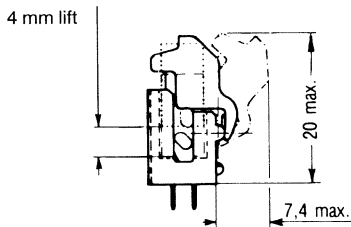

Locking hook long, for female connector with strain-relief clamp

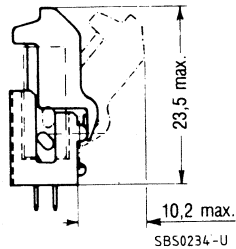

Insulation-Displacement Connectors for Ribbon Cables BK-MOD 421/422

Female connector comprising press-in plate and upper section

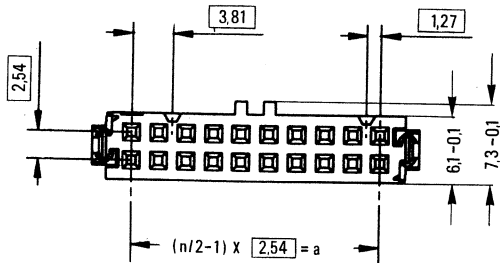

Number of contacts	Dimensions in mm	
	a	b max.
6	5,08	12,20
10	10,16	17,30
14	15,24	22,40
16	17,78	24,90
20	22,86	30,00
26	30,48	37,60
34	40,64	47,80
40	48,26	55,40
50	60,96	68,10
60	73,66	80,80
64	78,74	85,90

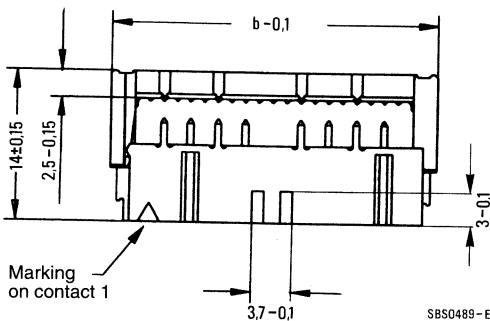

Strain-relief clamp

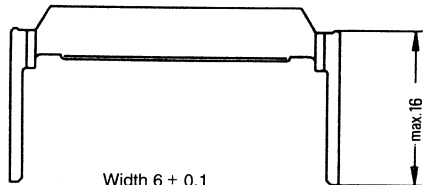

SBS0490-H

Assignment information (View on insulation-displacement terminal contacts)

Contact 1 / conductor 1 (edge conductor)

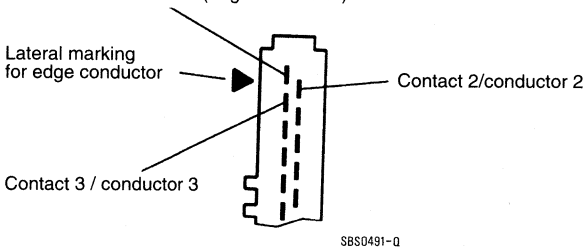

Version

- Header for printed circuits
- Suitable cable cross-sections in acc. with DIN/VDE 0811:
stranded wire $0,09 \text{ mm}^2$ (AWG 28/7) and $0,14 \text{ mm}^2$ (AWG 26/7)
solid wire $0,25 \text{ mm } \varnothing$ (AWG 30/1) and $0,32 \text{ mm } \varnothing$ (AWG 28/1)
center spacing: $1,27 \text{ mm}$; insulation thickness: max. $1,1 \text{ mm}$
- Center polarization (except version with 6 contacts) and polarizing lugs
- Female connector with pre-latched press-in plate

Insulation-Displacement Connectors for Ribbon Cables BK-MOD 421/422

Technical data

Dielectric	thermoplastic material, glass-fiber reinforced	
Contact material	copper alloy	
	Pin connector	Female connector
Contact surface	Contact pin: Pd on Au (flash) Solder pin: tin on nickel	Insertion area: double contact, Pd on Au (flash) Ins.displacem.term.: tin on nickel
Current rating per contact at 20 °C/70 °C/100 °C	1,5 A/1 A/0,5 A	
Test voltage contact-contact	0,94 kV	
Insulation resistance	≥ 10 ⁵ MΩ	
Flammability	in compliance with UL 94 V-0	
Temperature range	- 55 ... + 125 °C	
Connection frequency	performance level 2 ≥ 200 insertion/removal cycles	

For the assembly of the connectors with ribbon cables tools are available for single-item production as well as for quantity production. Available on request.

Number of contacts	Ordering code	DU						
		Pcs						
Standard header with straight solder pins (without locking facility)								
6	V23535-A1200-A60	100						
10	V23535-A1200-A100	100						
14	V23535-A1200-A140	100						
16	V23535-A1200-A160	100						
20	V23535-A1200-A200	100						
26	V23535-A1200-A260	100						
34	V23535-A1200-A340	100						
40	V23535-A1200-A400	50						
50	V23535-A1200-A500	50						
60	V23535-A1200-A600	50						
64	V23535-A1200-A640	50						
Standard header with solder pins angled at 90° (without locking facility)								
6	V23535-A1210-A60	100						
10	V23535-A1210-A100	100						
14	V23535-A1210-A140	100						
16	V23535-A1210-A160	100						
20	V23535-A1210-A200	100						
26	V23535-A1210-A260	100						
34	V23535-A1210-A340	100						
40	V23535-A1210-A400	50						
50	V23535-A1210-A500	50						
60	V23535-A1210-A600	50						
64	V23535-A1210-A640	50						
Locking hooks for standard header (2 hooks required per header)								
short	C42334-A421-C30	100						
long	C42334-A421-C31	100						

Connectors

Insulation-Displacement Connectors for Ribbon Cables

BK-MOD 421/422

Number of contacts	Ordering code	DU								
		Pcs								
Compact header with straight solder pins (without locking facility)										
6	V23535-A2200-A60	80								
10	V23535-A2200-A100	80								
14	V23535-A2200-A140	80								
16	V23535-A2200-A160	80								
20	V23535-A2200-A200	80								
26	V23535-A2200-A260	40								
34	V23535-A2200-A340	40								
Compact header with solder pins angled at 90° (without locking facility)										
6	V23535-A2210-A60	80								
10	V23535-A2210-A100	80								
14	V23535-A2210-A140	80								
16	V23535-A2210-A160	80								
20	V23535-A2210-A200	80								
26	V23535-A2210-A260	40								
34	V23535-A2210-A340	40								
Locking hook for compact header (1 hook right and 1 hook left per header required)										
short, right-hand	C42334-A421-C41	80								
short, left-hand	C42334-A421-C51	80								
long, right-hand	C42334-A421-C42	80								
long, left-hand	C42334-A421-C52	80								
Female connector (without strain-relief clamp)										
6	V23535-A3280-C61	100								
10	V23535-A3280-C101	100								
14	V23535-A3280-C141	100								
16	V23535-A3280-C161	100								
20	V23535-A3280-C201	100								
26	V23535-A3280-C261	100								
34	V23535-A3280-C341	100								
40	V23535-A3280-C401	100								
50	V23535-A3280-C501	100								
60	V23535-A3280-C601	100								
64	V23535-A3280-C641	100								
Strain-relief clamp (1 clamp per female connector required)										
6	C42334-A422-C306	50								
10	C42334-A422-C310	50								
14	C42334-A422-C314	50								
16	C42334-A422-C316	50								
20	C42334-A422-C320	50								
26	C42334-A422-C326	50								
34	C42334-A422-C334	50								
40	C42334-A422-C340	50								
50	C42334-A422-C350	50								
60	C42334-A422-C360	50								
64	C42334-A422-C364	50								

Connectors Sub-D with Soldering Terminals

Pin and female connectors

9, 15, 25, 37 and 50 contacts
With \varnothing 3 mm holes

Pin connector with screen braiding

with solder lugs for conventional wiring with straight solder pins for printed circuits



The specified dimensions are mounting dimensions (deviations are within the standard tolerances).

Number of contacts	Connector	Dimensions in mm					
		A	B	C	D	E	G
	Pin	- 0,76	+ 0,25		+ 0,25	- 0,76	- 0,3
	Female	- 0,76	- 0,25		- 0,25	- 0,76	- 0,25
9	Pin	31,19	16,79	25 + 0,12/- 0,13 Se	8,23	12,93	6,12
9	Female	31,19	16,46	25 + 0,12/- 0,13 Se	8,02	12,93	6,3
15	Pin	39,52	25,12	33,3 + 0,15/- 0,1	8,23	12,93	6,12
15	Female	39,52	24,79	33,3 + 0,15/- 0,1	8,02	12,93	6,3
25	Pin	53,42	38,84	47,04 +/- 0,13	8,23	12,93	5,99
25	Female	53,42	38,5	47,04 +/- 0,13	8,02	12,93	6,3
37	Pin	69,7	55,3	63,5 +/- 0,13	8,23	12,93	5,99
37	Female	69,7	54,96	63,5 +/- 0,13	8,02	12,93	6,3
50 ¹⁾	Pin	67,31	52,68	61,10 + 0,14/- 0,11	10,95	15,75	5,99
50 ¹⁾	Female	67,31	52,55	61,10 + 0,14/- 0,11	10,87	15,75	6,3

1) 3-row dielectric

Connectors Sub-D with Soldering Terminals

Technical data

Dielectric	thermoplastic material, glass-fiber reinforced
Protective collar	steel, nickel-plated and tinned
Contacts	copper alloy, punched/rolled, insertion area Au/Pd on Ni, performance level 2
Tails	tinned
Current rating per contact (at 20 °C ambient temperature)	5 A
Dielectric strength (test voltage) at 860 ... 1060 mbar atm. pressure	1000 V, 50 Hz
Contact resistance	≤ 15 mΩ
Insulation resistance	≥ 5 · 10 ⁹ Ω
Service life (performance level 2)	≥ 250 insertion/removal cycles
Flammability	self-extinguishing after < 10 s, UL 94 V-0
Temperature range	- 55 ... + 125°C
Approvals	UL listed: File E 92320

Item	Number of con- tacts	Ordering code	DU											
Connector			Pcs											

With solder lugs; Ø 3 mm holes

Pin	9	V42254-A1115-C209	70											
Female	9	V42254-A1115-B209	70											
Pin	15	V42254-A1115-C215	70											
Female	15	V42254-A1115-B215	70											
Pin	25	V42254-A1115-C225	60											
Female	25	V42254-A1115-B225	60											
Pin	37	V42254-A1115-C237	60											
Female	37	V42254-A1115-B237	60											
Pin	50	V42254-A1115-C250	55											
Female	50	V42254-A1115-B250	55											

With solder pins (2,76 mm × 2,84 mm center spacing); Ø 3 mm holes

Pin	9	V42254-A2115-C209	70											
Female	9	V42254-A2115-B209	70											
Pin	15	V42254-A2115-C215	70											
Female	15	V42254-A2115-B215	70											
Pin	25	V42254-A2115-C225	60											
Female	25	V42254-A2115-B225	60											
Female	37	V42254-A2115-B237	60											
Pin	50	V42254-A2115-C250	55											
Female	50	V42254-A2115-B250	55											

Connectors Sub-D with Soldering Terminals

Pin and female connectors

9, 15 and 25 contacts

With solder pins for printed circuits

With grounding plate, grounding solder pins and threaded bolt

Pin connectors with screen braiding

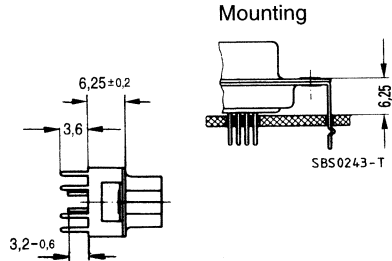
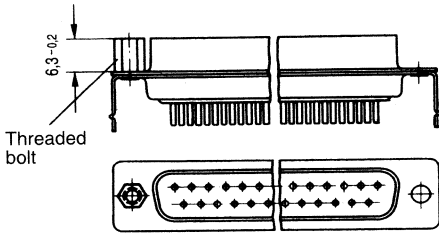

Outline drawing shows only 1 threaded bolt

For dimensions not specified here, see page 163

Mounting holes (component side) for printed circuits

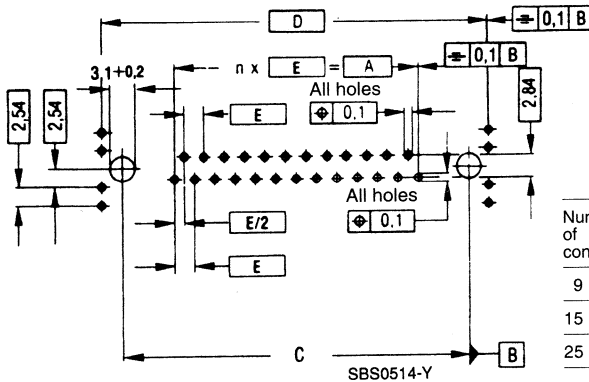

All holes $\varnothing 1 \pm 0,1$;
Through-plated holes
are recommended

Number of contacts	n	Dimensions in mm			
		A	C $\pm 0,1$	D	E
9	4	10,96	25,0	30,4	2,74
15	7	19,18	33,3	38,8	2,74
25	12	33,12	47,04	52,7	2,76

Item	Number of contacts	Ordering code	DU						
Connector			Pcs						
Pin	9	V42254-A2216-C209	70						
Female	9	V42254-A2216-B209	70						
Pin	15	V42254-A2216-C215	70						
Female	15	V42254-A2216-B215	70						
Pin	25	V42254-A2216-C225	60						
Female	25	V42254-A2216-B225	60						

Connectors Sub-D with Soldering Terminals

Pin and female connectors (angle connectors)

9, 15, 25, 37 and 50 contacts

Solder pins angled at 90°, for printed circuits

Pin connectors with screen braiding

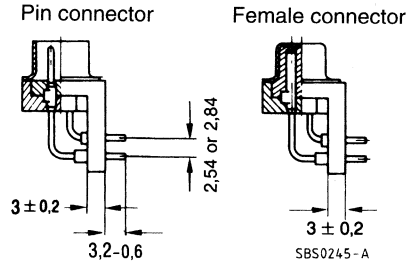
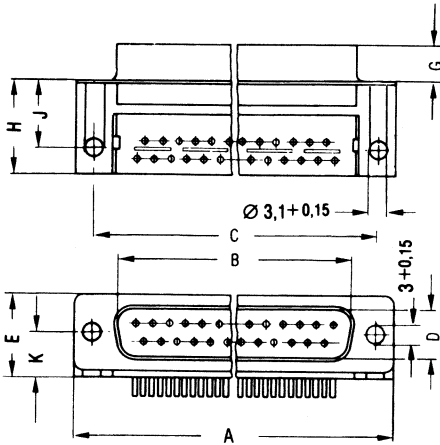

Number of contacts	Connector	Dimensions in mm								
		A	B	C	D	E	G	H	J	K
	Pin	-0,76	-0,25	-0,25	+0,25	max.	-0,3	max.	±0,2	±0,2
	Female	-0,76	-0,25	-0,25	-0,25	max.	-0,25	max.	±0,2	±0,2
9	Pin	31,19	16,79	25,12	8,23	13,9	6,12	16	11,7	7,3
9	Female	31,19	16,46	25,12	8,02	13,9	6,3	16	11,7	7,3
15	Pin	39,52	25,12	33,45	8,23	13,9	6,12	16	11,7	7,3
15	Female	39,52	24,79	33,45	8,02	13,9	6,3	16	11,7	7,3
25	Pin	53,42	38,84	47,17	8,23	13,9	5,99	16	11,7	7,3
25	Female	53,42	38,5	47,17	8,02	13,9	6,3	16	11,7	7,3
37	Pin	69,7	55,3	63,63	8,23	13,9	5,99	16	11,7	7,3
37	Female	69,7	54,96	63,63	8,02	13,9	6,3	16	11,7	7,3
50 ¹⁾	Pin	67,31	52,68	61,24	10,95	16,75	5,99	18,6	13,1	8,7
50 ¹⁾	Female	67,31	52,68	61,24	10,87	16,75	6,3	18,6	13,1	8,7

1) 3-row dielectric

Connectors Sub-D with Soldering Terminals

Item	Number of contacts	Ordering code	DU										
Connector			Pcs										
With solder pins (2,76 mm × 2,54 mm center spacing)													
Pin	9	V42254-A3226-C209	56										
Female	9	V42254-A3226-B209	56										
Pin	15	V42254-A3226-C215	56										
Female	15	V42254-A3226-B215	56										
Pin	25	V42254-A3226-C225	40										
Female	25	V42254-A3226-B225	40										
Pin	37	V42254-A3226-C237	40										
Female	37	V42254-A3226-B237	40										
Pin	50	V42254-A3226-C250	35										
Female	50	V42254-A3226-B250	35										

Connectors Sub-D with Soldering Terminals

Pin and female connectors (angle connectors)

With metal bracket, mounting height 3,6 mm

9, 15, 25 and 37 contacts

Solder pins angled at 90°, for printed circuits

With $\varnothing 3$ mm holes or with 4-40 UNC thread and mounting clips

Pin connector with screen braiding

The metal bracket ensures optimum grounding

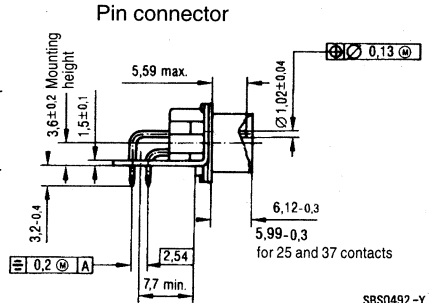
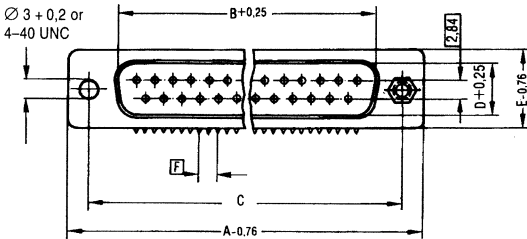

SBS0492-Y

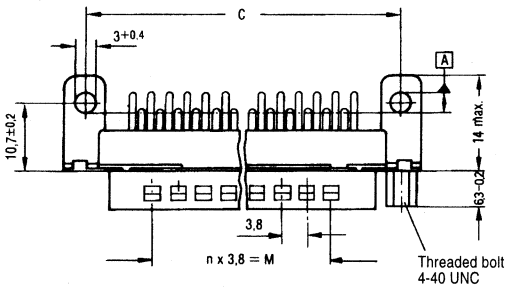

Female connector

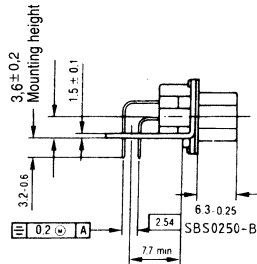

Version with mounting clips

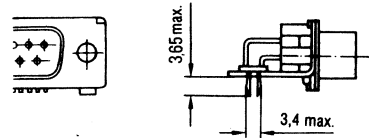

SBS0493-7

Number of contacts	Connector	Dimensions in mm							
		A	B	C	D	E	F	M	n
9	Pin	31,19	16,79	25,0 + 0,12/- 0,13	8,23	12,93	2,74	7,6	2
9	Female	31,19	16,46	25,0 + 0,12/- 0,13	8,02	12,93	2,74	-	-
15	Pin	39,52	25,12	33,3 + 0,15/- 0,1	8,23	12,93	2,74	15,2	4
15	Female	39,52	24,79	33,3 + 0,15/- 0,1	8,02	12,93	2,74	-	-
25	Pin	53,42	38,84	47,04 + 0,13/- 0,13	8,23	12,93	2,76	26,6	7
25	Female	53,42	38,5	47,04 + 0,13/- 0,13	8,02	12,93	2,76	-	-
37	Pin	69,7	55,3	63,5 + 0,13/- 0,13	8,23	12,93	2,76	41,8	11
37	Female	69,7	54,96	63,5 + 0,13/- 0,13	8,02	12,93	2,76	-	-

Connectors Sub-D with Soldering Terminals

Item	Number of contacts	Ordering code	DU									
Connector			Pcs									
With solder pins (2,76 mm × 2,54 mm center spacing); Ø 3 mm holes												
Pin	9	V23529-B1121-C209	100									
Female	9	V23529-B1121-B209	100									
Pin	15	V23529-B1121-C215	100									
Female	15	V23529-B1121-B215	100									
Pin	25	V23529-B1121-C225	50									
Female	25	V23529-B1121-B225	50									
Pin	37	V23529-B1121-C237	50									
Female	37	V23529-B1121-B237	50									
With solder pins (2,76 mm × 2,54 mm center spacing); with 4-40 UNC thread and mounting clip												
Pin	9	V23529-B1223-C209	100									
Pin	15	V23529-B1223-C215	100									
Female	15	V23529-B1223-B215	100									
Pin	25	V23529-B1223-C225	50									
Female	25	V23529-B1223-B225	50									
Female	37	V23529-B1223-B237	50									

Connectors Sub-D with Solder Terminal

Pin and female connectors (angle connectors)

With metal bracket, mounting height 7,3 mm
9, 15, 25 and 37 contacts

Solder pins angled at 90°, for printed circuits

With \varnothing 3 mm holes, 4-40 UNC threaded bolt or 4-40 UNC threads and mounting clips
Pin connector with screen braiding

The metal bracket ensures optimum grounding

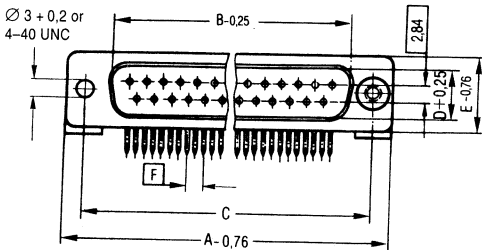

Pin connector

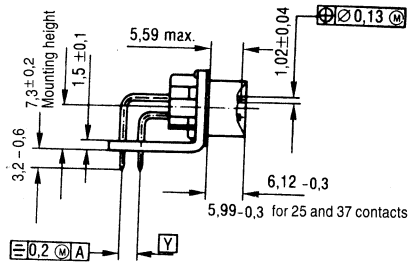

SBS0494 - F

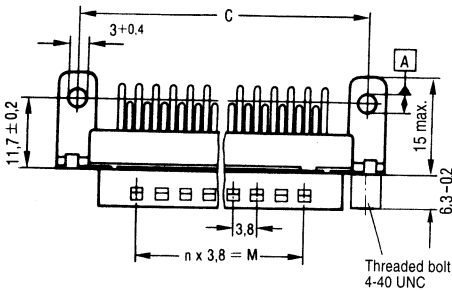

Female connector

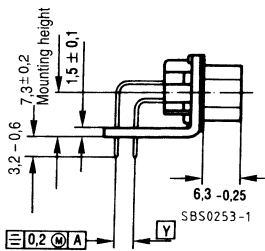

For dimensions of pin and female connector refer to page 166

Version with mounting clip

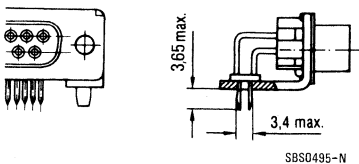

Connectors Sub-D with Solder Terminal

Item	Number of contacts	Ordering code	DU										
Connector			Pcs										
With solder pins (2,76 mm × 2,84 mm center spacing); Ø 3 mm holes													
Pin	9	V23529-A1111-C209	100										
Female	9	V23529-A1111-B209	100										
Pin	15	V23529-A1111-C215	100										
Female	15	V23529-A1111-B215	100										
Pin	25	V23529-A1111-C225	50										
Female	25	V23529-A1111-B225	50										
Pin	37	V23529-A1111-C237	50										
Female	37	V23529-A1111-B237	50										
With solder pins (2,76 mm × 2,84 mm center spacing); 4-40 UNC threaded bolt													
Pin	9	V23529-A1115-C209	100										
Female	9	V23529-A1115-B209	100										
Pin	15	V23529-A1115-C215	100										
Female	15	V23529-A1115-B215	100										
Pin	25	V23529-A1115-C225	50										
Female	25	V23529-A1115-B225	50										
Pin	37	V23529-A1115-C237	50										
Female	37	V23529-A1115-B237	50										
With solder pins (2,76 mm × 2,54 mm center spacing); 4-40 UNC thread and mounting clip													
Pin	9	V23529-A1223-C209	100										
Female	9	V23529-A1223-B209	100										
Pin	15	V23529-A1223-C215	100										
Female	15	V23529-A1223-B215	100										
Pin	25	V23529-A1223-C225	50										
Female	25	V23529-A1223-B225	50										
Pin	37	V23529-A1223-C237	50										
Female	37	V23529-A1223-B237	50										

Connectors Sub-D with Insulation-Displacement Terminal

Pin and female connectors

With insulation-displacement terminal for ribbon cables, round cables or single wires

Integrated strain relief

With $\varnothing 3$ mm holes

9, 15, 25 and 37 contacts

Pin connector

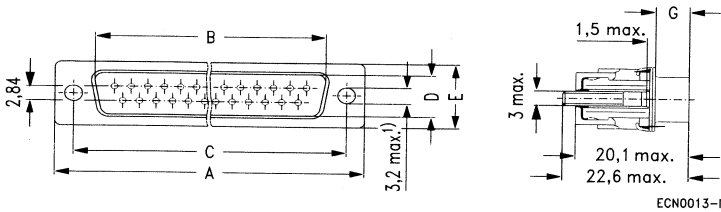

Number of contacts	Connector	Dimensions in mm						
		A	B	C	D	E	G	H
	Pin	-0,76	+0,25		+0,25	-0,76	-0,3	max.
	Female	-0,76	-0,25		-0,25	-0,76	-0,25	max.
9	Pin	31,19	16,79	25	8,23	12,93	6,12	18,6
9	Female	31,19	16,46	25 + 0,12/- 0,13 Se	8,02	12,93	6,3	18,6
15	Pin	39,52	25,12	33,3 + 0,15/- 0,1	8,23	12,93	6,12	26,9
15	Female	39,52	24,79	33,3 + 0,15/- 0,1	8,02	12,93	6,3	26,9
25	Pin	53,42	38,84	47,04 +/- 0,13	8,23	12,93	5,99	40,6
25	Female	53,42	38,5	47,04 +/- 0,13	8,02	12,93	6,3	40,6
37	Pin	69,7	55,3	63,5 +/- 0,13	8,23	12,93	5,99	57,1
37	Female	69,7	54,96	63,5 +/- 0,13	8,02	12,93	6,3	57,1

- 1) Plug mounting also with M3 or 4-40 UNC thread, if required.
- 2) Dimension with connected cable
- 3) Dimension with connected cable and strain-relief clamp

Connectors Sub-D with Insulation-Displacement Terminal

Technical data

Contacts	copper alloy, nickel and hard-gold-plated in the insertion area, tin-plated in the connection area
Current rating per contact at 20 °C/70 °C/100 °C	2 A/1 A/0,5 A
Test voltage	0,78 kV
Insulation resistance	≥ 5 × 10 ³ MΩ
Flammability	in compliance with UL 94 V-0
Temperature range	- 55 °C ... + 125 °C
Connection frequency	performance level 2: ≥ 250 insertion/removal cycles
Approvals	UL listed: File E 92320, Project 85 ME 3872
Connectable cables	ribbon cable AWG 26/28 stranded wire or AWG 28/30 solid

For the assembly of the connectors with ribbon cables tools are available for single-item production as well as for quantity production. Available on request.

Item	Number of con- tacts	Ordering code	DU												
Connector			Pcs												
With insulation-displacement terminals; Ø 3,2 mm holes															
Pin	9	V42254-A5235-C209	50												
Female	9	V42254-A5235-B209	50												
Pin	15	V42254-A5235-C215	40												
Female	15	V42254-A5235-B215	40												
Pin	25	V42254-A5235-C225	30												
Female	25	V42254-A5235-B225	30												
Pin	37	V42254-A5235-C237	30												
Female	37	V42254-A5235-B237	30												
Strain-relief clamp for ribbon cables															
	9	V42254-A4000-D9	25												
	15	V42254-A4000-D15	25												
	25	V42254-A4000-D25	25												
	37	V42254-A4000-D37	25												

Connectors Sub-D Housings

Housing size: 9 contacts

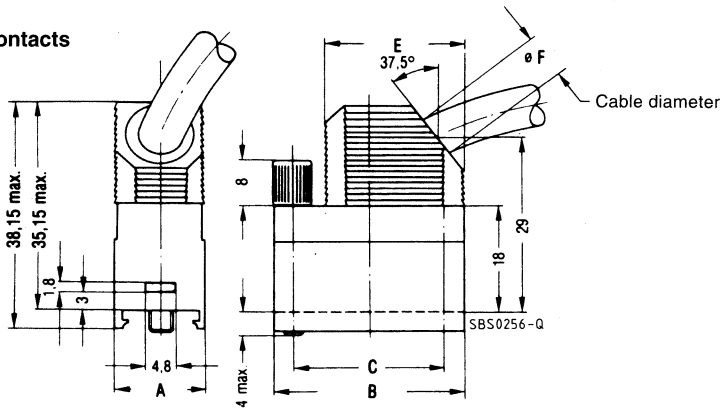

Housing size	Dimensions in mm					
	A (max.)	B (max.)	C	D	E	F (max.)
9 contacts	15	31,30	25	—	23,3	∅ 4 ... 8
15 contacts	15	39,62	33,3	16,5	23,3	∅ 5 ... 9
25 contacts	15	53,52	47	30,4	37	∅ 5 ... 11
37 contacts	15	69,80	63,5	46,7	53,5	∅ 5 ... 11
50 contacts	15	67,41	61,1	44,3	51,5	∅ 10 ... 14,6

Housing size: 15 to 50 contacts

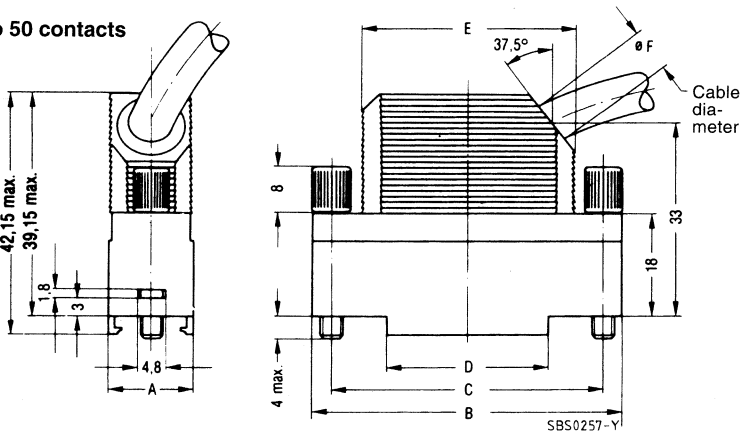

Housing is supplied without knurled screws, cable bushing and contact tube. (These parts are accessories)

Version

- Unscreened plastic housing comprising: Housing lower section and upper section and 2 differently sized cable clamps (1 required, size depends on cable diameter) with 3 screws for strain relief.
- Screened plastic housing comprising: Housing lower and upper section with fitted screening plates, 2 differently sized cable clamps (1 required, size depends on cable diameter) with 3 screws for strain relief and for securing the cable screen.
- Various locking methods possible
- Electromagnetic screening by metal plates which are fixed inside the plastic shells

Connectors Sub-D Housings/Housing Accessories

Technical data

Flammability	self-extinguishing after ≤ 10 s, UL 94 V-1
Temperature range	$-40 \dots +80$ °C
Screened version	
Attenuation at 10 MHz	≥ 60 dB
Peak voltage in the inner conductor with an electrostatic discharge of 15 kV	$\leq 1,5$ V

Housing size	Color	Ordering code	DU										
		V42254-	Pcs										

Unscreened housing

9 contacts	pebble grey RAL 7032	A6000-K109	25										
15 contacts		A6000-K115	25										
25 contacts		A6000-K125	15										
37 contacts		A6000-K137	15										
50 contacts		A6000-K150	15										
15 contacts	black RAL 9005	A6000-K315	125										

Screened housing

9 contacts	pebble grey RAL 7032	A6000-G109	25										
15 contacts		A6000-G115	25										
25 contacts		A6000-G125	15										
37 contacts		A6000-G137	15										
50 contacts		A6000-G150	15										
15 contacts	black RAL 9005	A6000-G315	25										

Variable housing accessories

Contact sleeves

For supporting the cable screen braiding

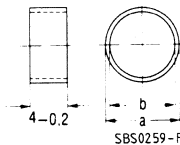

Material:
AlMg 3 F25

Dimensions a b mm		For screen braiding outer diameter mm	Ordering code	DU									
			V42254-	Pcs									
4	3	2,0 ... 2,8	A6104-L1	100									
5	4	2,9 ... 3,8	A6105-L1	100									
6	5	3,9 ... 4,8	A6106-L1	100									
7	6	4,9 ... 5,8	A6107-L1	100									
8	7	5,9 ... 6,8	A6108-L1	100									
9	8	6,9 ... 7,8	A6109-L1	100									
10	9	7,9 ... 8,8	A6110-L1	100									
12	11	9,9 ... 10,8	A6112-L1	100									

Connectors Sub-D Housing Accessories

Cable bushings

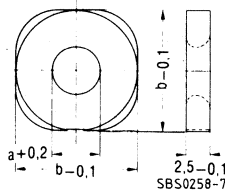

Color grey

Material:
PBTP GF 30

For housing size (number of contacts)					Dimensions		For line outer diameter mm	Ordering code V42254-	DU Pcs
9	15	25	37	50	a mm	b mm			
×					5	12,9	4,2 ... 4,9	A6205-L1	100
×	×				6	12,9	5,0 ... 5,9	A6206-L1	100
×	×	×	×		7	12,9	6,0 ... 6,9	A6207-L1	100
×	×	×	×		8	12,9	7,0 ... 7,9	A6208-L1	100
	×	×	×		9	12,9	8,0 ... 8,9	A6209-L1	100
		×	×		11	12,9	10,0 ... 10,9	A6211-L1	100
				×	10	16,9	9,0 ... 9,9	A6210-L50	100
				×	13	16,9	12,0 ... 12,9	A6213-L50	100

Knurled screw ¹⁾ for screw locking

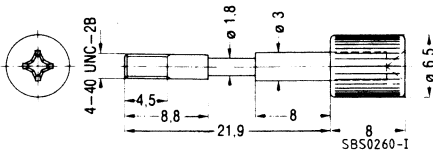

With plastic head (grey or black),
Material: 9 S MnPb 28 K-3, nickel-plated
surface, injection-molded head
of PBTP GF 30

or with solid-metal head,
Material: free-cutting steel, nickel-plated

Screw with nut for connector mounting without locking

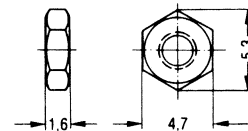
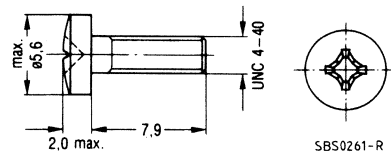

Material: screw as per MS 51957,
stainless steel, surface passivated

Item	Ordering code V42254-	DU Pcs/ Satz
------	------------------------------------	--------------------

Knurled screw

Grey plastic	A112-V9	10
Black plastic	A112-V109	10
Metal	A262-V19	10

Set of screws comprising

2 screws and 2 nuts	A162-V1	10
---------------------	---------	----

1) 1 screw is required for housings with 9 contacts. 2 screws are required for housings with 15, 25, 37 and 50 contacts.

Connectors Sub-D Zubehör

Bolt sets

for equipment connectors mounted from the inside

Mounting method A

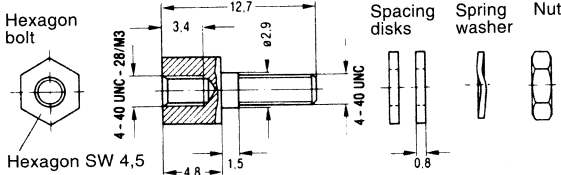

Mounting method B

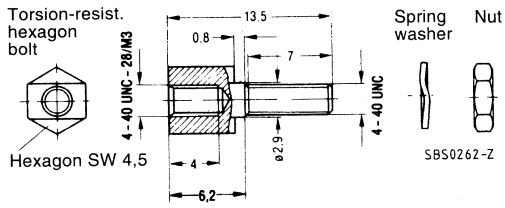

Dimensions in mm

for equipment connectors mounted from the outside

Mounting method C

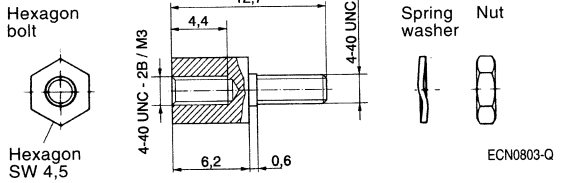

Mounting method D

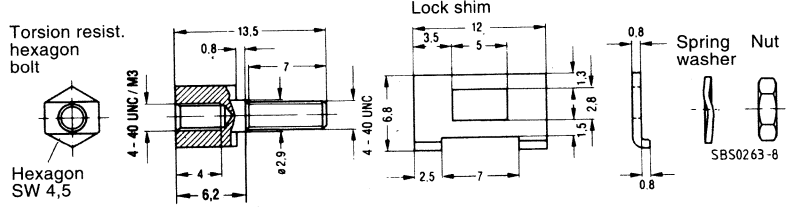

Item	Ordering code	DU					
		DU set					
Set of bolts for mounting method A (comprises 2 bolts, 4 washers, 2 spring washers and 2 nuts)	A122-V1	10					
Set of bolts for mounting method B (comprises 2 bolts, 2 spring washers and 2 nuts)	A152-V1	10					
Set of bolts for mounting method C (comprises 2 bolts, 2 spring washers and 2 nuts)	A132-V1	10					
Set of bolts for mounting method D (comprises 2 bolts, 2 lock shims, 2 spring washers and 2 nuts)	A142-V1	10					

Connectors

Connectors DIN 41618 and DIN 41622

Two-Part Connectors RP 618

Blade-contact and female connectors in acc. with DIN 41 618

With solder lugs for conventional wiring
20, 26 and 39 contacts

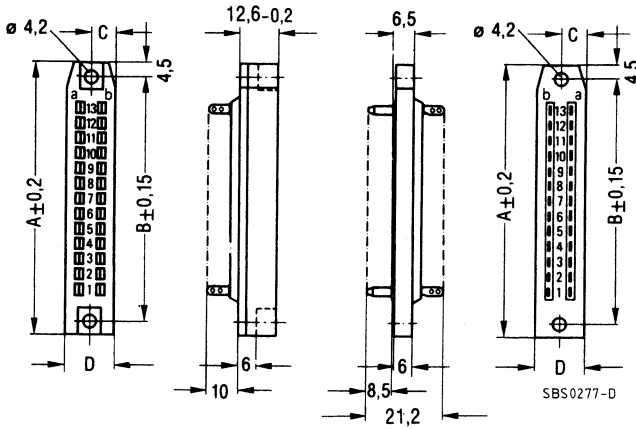

Size	Number of contacts	Dimensions in mm			
		A	B	C	D
3	20	71	62	7,5	15 ± 0,1
4	26	83	74	7,5	15 ± 0,1
5 ¹⁾	39	83	74	10	20 ± 0,15

Technical data

Dielectric

Contact surface

Version

Current rating per contact
(at 20°C ambient temperature)

Operating voltage (as per VDE 0110 group A)

Contact resistance

Insulation resistance

Service life

Temperature range

thermoplastic material, glass-fiber reinforced

silver-plated

gold-plated

complying with
VG 95322

8 A

6 A

300 Vdc/250 Vac rms

≤ 5 mΩ

≤ 8 mΩ

≥ 10⁶ MΩ

≥ 1000 insertion/removal cycles

- 55 ... + 155 °C

1) 3-row dielectric

Connectors DIN 41618 and DIN 41622

Two-Part Connectors RP 618

Item	Number of contacts	Ordering code	DU								
Connector			Pcs								

Silver-plated contact surface

Blade	20	C42334-A47-A5	40								
Female	20	C42334-A47-A6	40								
Blade	26	C42334-A48-A5	40								
Female	26	C42334-A48-A6	40								
Blade	39	C42334-A49-A5	40								
Female	39	C42334-A49-A6	40								

Gold-plated contact surface

Blade	26	C42334-A48-A15	40								
Female	26	C42334-A48-A36	40								
Blade	39	C42334-A49-A15	40								
Female	39	C42334-A49-A36	40								

Connectors DIN 41618 and DIN 41622

Two-Part Connectors RP 622

Blade-contact and female connectors in acc. with DIN 41622

With solder lugs for conventional wiring
8, 12, 16, 20 and 30 contacts

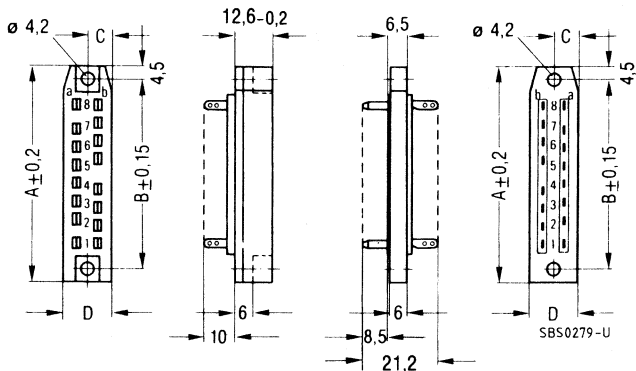

Size	Number of contacts	Dimensions in mm			
		A	B	C	D
1	8	47	38	7,5	15 ± 0,1
2	12	59	50	7,5	15 ± 0,1
3	16	71	62	7,5	15 ± 0,1
4	20	83	74	7,5	15 ± 0,1
5 ¹⁾	30	83	74	10	20 ± 0,15

Technical data

Dielectric	thermoplastic material, glass-fiber reinforced
Contact surface	silver-plated
Version	complying with VG 95322
Current rating per contact (at 20°C ambient temperature)	10 A
Operating voltage (as per VDE 0110 group A)	450 V/380 Vac rms
Contact resistance	≤ 5 mΩ
Insulation resistance	≥ 10 ⁶ MΩ
Service life	≥ 1000 insertion/removal cycles
Temperature range	- 55 ... + 155 °C

1) 3-row dielectric

Connectors DIN 41618 and DIN 41622 Two-Part Connectors RP 622

Item	Number of contacts	Ordering code	DU							
Connector			Pcs							

Silver-plated contact surface

Blade	8	C42334-A40-A5	30							
Female	8	C42334-A40-A6	30							
Blade	12	C42334-A41-A5	30							
Female	12	C42334-A41-A6	30							
Blade	16	C42334-A42-A5	40							
Female	16	C42334-A42-A6	40							
Blade	20	C42334-A43-A5	40							
Female	20	C42334-A43-A6	40							
Blade	30	C42334-A44-A5	40							
Female	30	C42334-A44-A6	40							

Gold-plated contact surface

Blade	30	C42334-A44-A15	40							
Female	30	C42334-A44-A36	40							

Connectors DIN 41618 and DIN 41622

Two-Part Connectors RP 300

Blade-contact and female connectors

(Mounting conditions and dimensions in acc. with DIN 41 618 and DIN 41 622)

With solder lugs for conventional wiring

21, 33, 42, 54 and 72 contacts

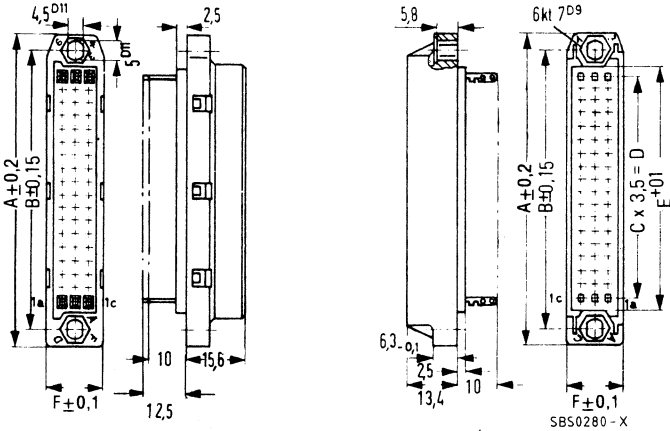

Size	Number of contacts	Dimensions in mm					
		A	B	C	D	E	F
1	21	47	38	6	21	27,2	15
2	33	59	50	10	35	41,2	15
3	42	71	62	13	45,5	51,7	15
4	54	83	74	17	59,5	65,1	15
5 ¹⁾	72	83	74	17	59,5	65,1	20

Current rating per contact (at 20 °C)

4,5 A

Contact resistance

≤ 15 mΩ

Temperature range

- 55 ... + 125 °C

For further data refer to page 178

Item	Number of contacts	Service life Insertion/removal cycles (≥)	Ordering code	DU					
Con- nector			C42334-	Pcs					

Gold-plated contact surface

Blade	21	1000	A300-A13	30					
Female	21	1000	A300-A14	30					
Blade	33	1000	A301-A13	30					
Female	33	1000	A301-A14	30					
Blade	42	1000	A302-A13	40					
Female	42	1000	A302-A14	40					
Blade	54	1000	A303-A13	40					
Female	54	1000	A303-A14	40					
Blade	72	1000	A304-A13	40					
Female	72	1000	A304-A14	40					

1) 4-row dielectric

Connectors DIN 41618 and DIN 41622 Accessories

Cable connector housing, diagonal cable entry, with locking facility

Metal version, black lacquer coating

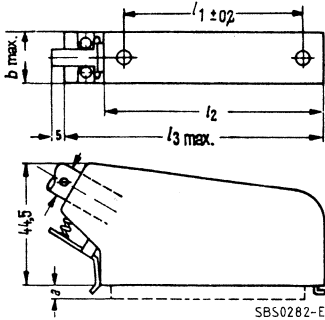

Size	Dimensions in mm				
	l_1	l_2	l_3	b	Cable \varnothing max.
1	38	54,5	70	18,2	12
2	50	66,5	82	18,2	12
3	62	78,5	94	18,2	12
4	74	90,5	106	18,2	12
5	74	90,5	106	23,2	16

Dimension a: 4.5 mm for blade-contact connector
3 textS 316.11

Locking tray

Steel, black lacquer coating

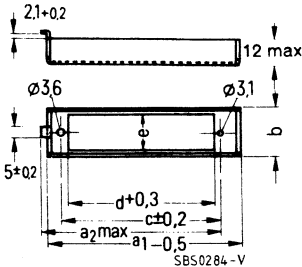

Size	Dimensions in mm					
	a_1	a_2	b	c	d	e
1	53	48	18,1	38	31	13
2	65	60	18,1	50	43	13
3	77	72	18,1	62	55	13
4	89	84	18,1	74	67	13
5	89	84	23,1	74	67	18

Size	For rack connectors			Ordering code	DU					
	Number of contacts									
	RP300	RP618	RP622	C42334-	Pcs					

Cable connector housing (without rack connector and matching parts)

1	21	10	8	A228-A441	10					
2	33	-	12	A228-A442	10					
3	42	20	16	A228-A443	10					
4	54	26	20	A228-A444	10					
5	72	39	30	A228-A445	10					

Locking tray

1	21	10	8	A228-C171	5					
2	33	-	12	A228-C172	5					
3	42	20	16	A228-C173	5					
4	54	26	20	A228-C174	5					
5	72	39	30	A228-C175	5					

Connectors DIN 41618 and DIN 41622 Accessories

Cable connector housing, diagonal cable entry, optionally with locking facility

Plastic version, pumice grey, fully insulated

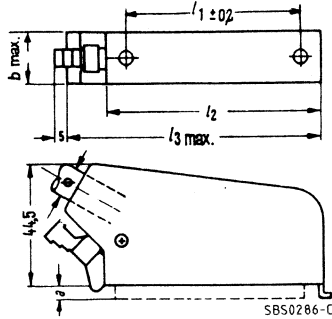

Size	Dimensions in mm				
	l_1	l_2 max.	l_3	b	Cable \varnothing max.
1	38	54,5	70	18,2	12
2	50	66,5	82	18,2	12
3	62	78,5	94	18,2	12
4	74	90,5	106	18,2	12
5	74	90,5	106	23,2	16

Dimension a: 4,5 mm for blade-contact connector
3 tetsS 314.17

Locking tray

Glass-fiber reinforced polycarbonate, pumice grey

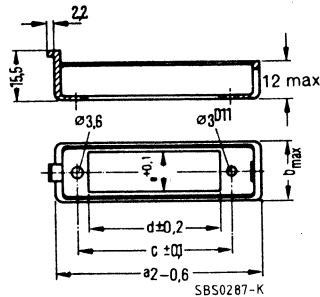

Size	Dimensions in mm				
	a_2	b	c	d	e
1	54,4	18,1	38	31	13
2	66,4	18,1	50	43	13
3	78,4	18,1	62	55	13
4	90,4	18,1	74	67	13
5	90,4	23,1	74	67	18

Note: The locking lever (not shown) is fixed to the housing subsequent to mounting

Size	For rack connectors			Ordering code	DU							
	Number of contacts					Pcs						
	RP618	RP622	RP300	C42334-								

Cable connector housing without locking facility (without rack connector and matching parts)

1	10	8	21	A228-A761	10							
2	—	12	33	A228-A762	10							
3	20	16	42	A228-A763	10							
4	26	20	54	A228-A764	10							
5	39	30	72	A228-A765	10							

Locking lever

—				A228-B78	20							
---	--	--	--	----------	----	--	--	--	--	--	--	--

Locking tray

1	10	8	21	A228-C161	10							
2	—	12	33	A228-C162	10							
3	20	16	42	A228-C163	10							
4	26	20	54	A228-C164	10							
5	39	30	72	A228-C165	10							

Connectors DIN 41618 and DIN 41622 Accessories

Matching parts

Pin

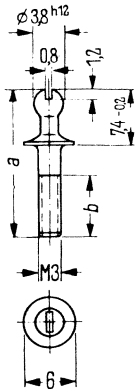

Socket

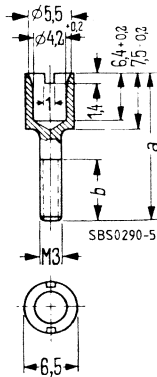

Retaining devices

Ball-head pin

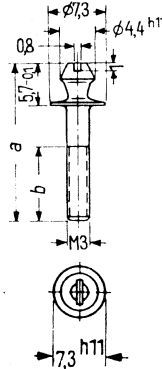

Latching spring

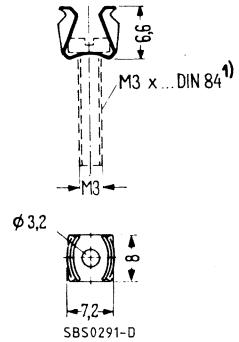

Note:

Dimension *a* depends on the thickness of the mounting plate or on whether nuts are used on through-holes.

Grounding socket

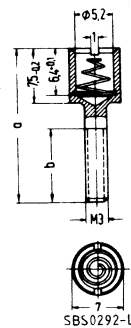

Item	Dimensions in mm		Ordering code	DU					
	<i>a</i>	<i>b</i>							
			C42334-	Pcs					
Pin	17,0	8	A100-C50	50					
Pin	19,5	8	A100-C51	50					
Socket	17,0	8	A100-C55	50					
Socket	19,5	8	A100-C56	50					
Socket	23,0	10	A100-C57	50					
Ball-head pin	17,7	8	A100-C61	50					
Latching spring	—	—	A100-C70	50					
Latching spring with screw M 3, 12 mm long	—	—	A100-B16	50					
Grounding socket	19,5	8	A100-B11	50					

1) Mounting hardware: Machine screws M 3 x ... DIN 84; recommended lengths: 10 mm, 12 mm and 15 mm (commercially available). Latching spring also available with screw M 3, 12 mm long

Connectors DIN 41618 and DIN 41622 Accessories

Cable sleeves

Material: PVC, black

For cable connector housings with diagonal cable entry, in conjunction with plastic jacketed cable. Suitable for sizes 1 to 5.

Sizes 1 to 4

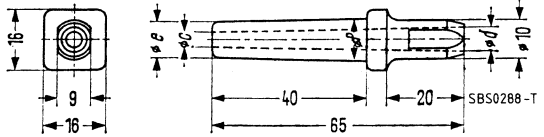

Size	Dimensions in mm			
	c	d	e	f
1 to 4	7	8	10	12
5	10,5	11,5	14	15,5

Size 5

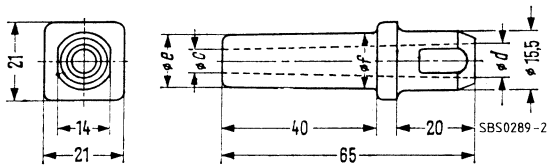

Polarizing elements

in particular for cable connectors RP 300

The notch on the polarizing element points to the letters and numbers on the dielectric.
Max. 36 polarizing positions

Securing e.g. by machine screw AM 3 × 12 DIN 84-5,8

Material: metal

Example: Blade-contact connector

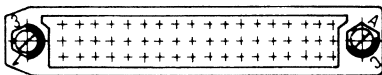

Example: Female connector

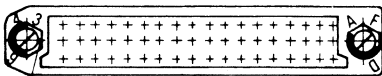

Notch on polarizing element

Mounting plate

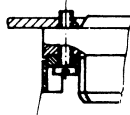

Polarizing element

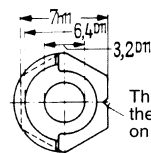
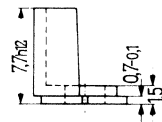

The notch points to the number or letter on the dielectric

SBS0293-U

Item	Ordering code	DU													
			Pcs												
Cable sleeve for sizes 1 to 4	A100-C42	50													
Cable sleeve for size 5	A100-C45	50													
Polarizing element	A303-C12	40													

Cable Connectors

Cable connector

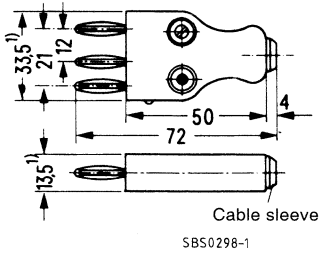

Item	Ordering code	DU									
		Pcs									
Cable connector, black	A282-A1	10									
Cable sleeve for cable connector	A282-C11	10									

1) Max. dimension

Coaxial Connectors

Series 1,0/2,3 (50 Ω and 75 Ω)

The connectors comply with CECC 22230. The construction follows the pin – socket principle, i.e. the inner and the outer conductor contacts are spring-loaded and made of gold-plated copper-beryllium alloy.

Series 1,0/2,3 (50 Ω)

The connectors with the characteristic impedance of 50 Ω can be used for frequencies up to 10 GHz.

Outline drawing 1

Bulkhead jack
with solder connection (50 Ω)
Coupling type style C, F

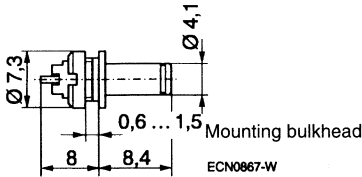

Outline drawing 2

Jack
with PC board connection (50 Ω)
Coupling type style C, F

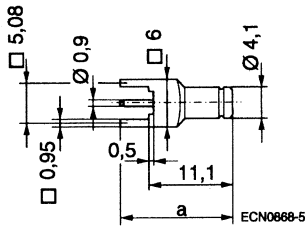

Dimension a = 14.6 mm

Pin arrangement for 2.54 mm grid

Outline drawing 3

Bulkhead angle jack with PC
board connection (50 Ω)
Coupling type style A, C, F

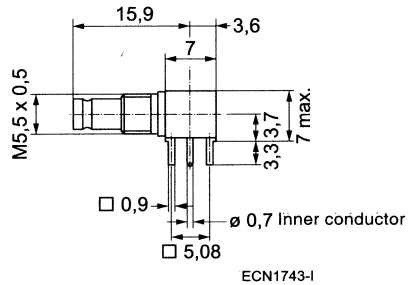

Pin arrangement for 2.54 mm grid

Coupling type style A: for push-screw coupling
Coupling type style C: for slide-in coupling
Coupling type style F: for latching coupling (Quick Lock)

Outline drawing	Ordering code	DU							
		Pcs							
1	C42334-A285-A602	25							
2	V23600-A1027-C1	100							
NEW 3	V23600-A1227-G4	100							

Coaxial Connectors

Series 1,0/2,3 (50 Ω and 75 Ω)

Series 1,0/2,3 (75 Ω)

The connectors with the characteristics impedance of 75 Ω can be used for frequencies of up to 2 GHz. They are plug-compatible and mounting-compatible with the existing 50 Ω - connectors.

Outline drawing 4

Cable angle plug (75 Ω)
Coupling type style F
for cables: Ø 3,6 02Y(St)CY 0,45/2,0

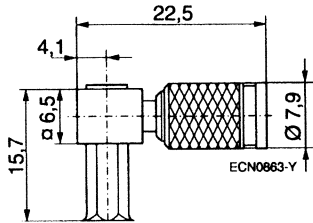

Outline drawing 5

Bulkhead jack with cable connection
for slide-in application (75 Ω)
Coupling type style C, F
for cables Ø 2,67 RG 179

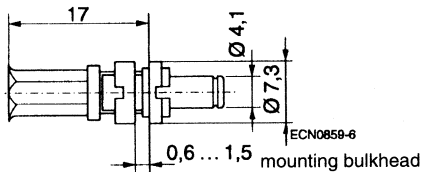

Outline drawing 6

Cable plug (75 Ω)
Coupling type style F
for cables Ø 2,67 RG 179
or Ø 3,6 02Y(St)CY 0,45/2,0

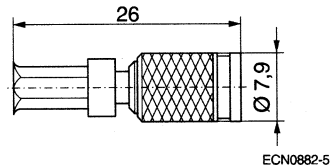

Coupling type style C: for slide-in coupling
Coupling type style F: for latching coupling (Quick Lock)

Outline drawing	Cable Ø (mm)	Ordering code	DU Pcs						
NEW 4	3,6	V23614-A263-P76	25						
5	2,67	V23614-A602-C57	25						
NEW 6	2,67	V23614-A102-P57	25						
NEW 6	3,6	V23614-A102-P76	25						

Coaxial Connectors

Series 1,6/5,6 mS (75 Ω)

The coaxial connectors series 1,6/5,6 mS are a follow-on development of the series 1,6/5,6 as specified in CECC 22240. These connectors can be used for frequencies up to 4 GHz. Connectors of series 1,6/5,6 mS are fully compatible to series 1,6/5,6 within the hitherto defined frequency range.

Outline drawing 1

Bulkhead jack with cable connection
Coupling type style A, B, F
for cables: \varnothing 3,6 02Y(St)CY 0,45/2,0
or \varnothing 4,8 2YCCY 0,4/2,5 and
 \varnothing 5,0 2YC(mS)CY 0,4/2,5

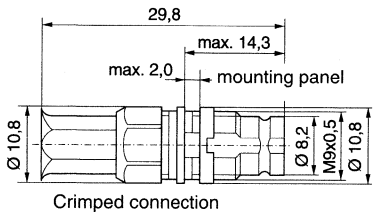

ECN0947-N

Outline drawing 2

Cable plug
Coupling type style A
for cables: \varnothing 3,6 02Y(St)CY 0,45/2,0
or \varnothing 4,8 2YCCY 0,4/2,5 and
 \varnothing 5,0 2YC(mS)CY 0,4/2,5

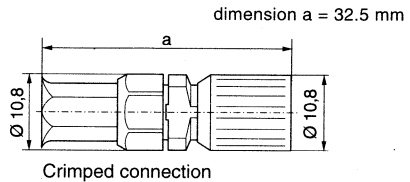

ECN0953-X

Outline drawing 3

Cable plug
Coupling type style F
for cables: \varnothing 3,6 02Y(St)CY 0,45/2,0

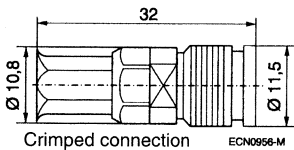

ECN0956-M

Outline drawing 4

Bulkhead jack with angle cable connection
Coupling type style A, B, F
for cables: \varnothing 3,6 02Y(St)CY 0,45/2,0

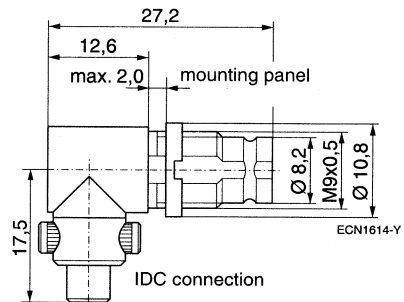

ECN1614-Y

Coupling type style A: for push-screw coupling
Coupling type style B: for snap-on coupling (push-pull)
Coupling type style F: for latching coupling (Quick Lock)

Outline drawing	Cable dia. (mm)	Ordering code	DU Pcs						
NEW 1	3,6	V23612-A602-G76	25						
NEW 1	4,8 and 5,0	V23612-A602-G45	25						
NEW 2	3,6	V23612-A102-A76	25						
NEW 2	4,8 and 5,0	V23612-A102-A45	25						
3	3,6	V23612-A102-P76	25						
NEW 4	3,6	V23612-A811-G76	25						

Coaxial Connectors

Series 1,6/5,6 mS (75 Ω)

Outline drawing 5

Bulkhead jack with angle cable connection
 Coupling type style A, B, F
 for cables: \varnothing 3,6 02Y(St)CY 0,45/2,0
 or \varnothing 4,8 2YCCY 0,4/2,5 and
 \varnothing 5,0 2YC(mS)CY 0,4/2,5

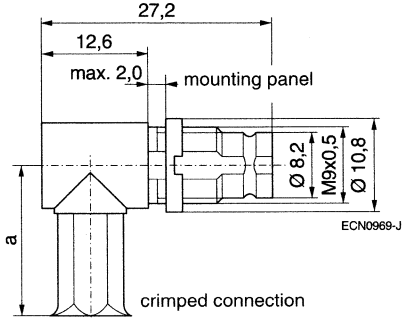

dimension a = 15 mm

Outline drawing 6

Cable angle plug
 Coupling type style A
 for cables: \varnothing 3,6 02Y(St)CY 0,45/2,0
 or \varnothing 4,8 2YCCY 0,4/2,5 and
 \varnothing 5,0 2YC(mS)CY 0,4/2,5

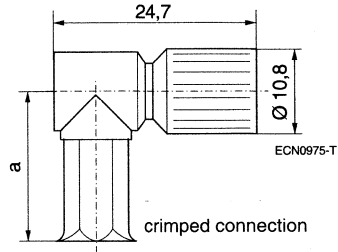

dimension a = 15 mm

Outline drawing 7

Cable angle-plug
 Coupling type style A
 for cables: \varnothing 3,6 02Y(St)CY 0,45/2,0

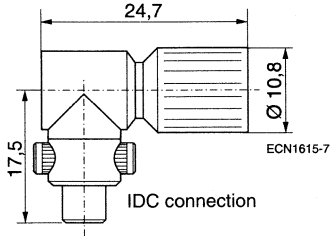

Outline drawing 8

Cable angle plug
 Coupling type style F
 for cables: \varnothing 3,6 02Y(St)CY 0,45/2,0

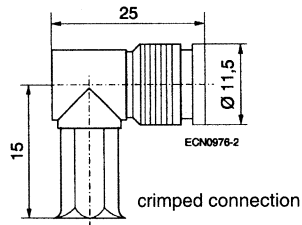

Coupling type style A: for push-screw coupling
 Coupling type style B: for snap-on coupling (push-pull)
 Coupling type style F: for latching coupling (Quick Lock)

Outline drawing	Cable dia. (mm)	Ordering code	DU Pcs						
NEW 5	3,6	V23612-A802-G76	25						
NEW 5	4,8 and 5,0	V23612-A802-G45	25						
NEW 6	3,6	V23612-A202-A76	25						
NEW 6	4,8 and 5,0	V23612-A202-A45	25						
NEW 7	3,6	V23612-A211-A76	25						
8	3,6	V23612-A202-P76	25						

Connectors

Coaxial Connectors

Series 1,6/5,6 mS (75 Ω)

Outline drawing 9

Bulkhead jack
with solder connection
Coupling type style A, B, C, F

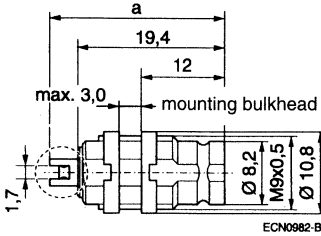

dimension a = 23,5 mm

Outline drawing 10

Bulkhead jack
with PC board connection
Coupling type style A, B, F

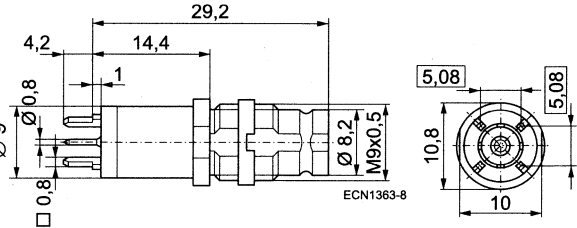

pin arrangement for 2,54 mm grid

Outline drawing 11

Jack with PC board connection; inner and
outer conductor by press-in technology
Coupling type style A, B, F

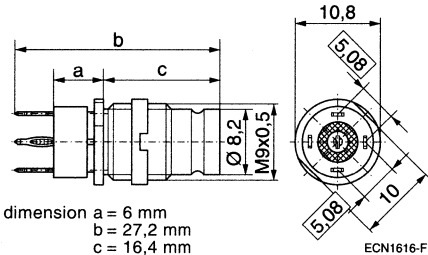

dimension a = 6 mm
b = 27,2 mm
c = 16,4 mm

pin arrangement for 2,54 mm grid

Outline drawing 12

Bulkhead angle jack
with PC board connection
Coupling type style A, B, F

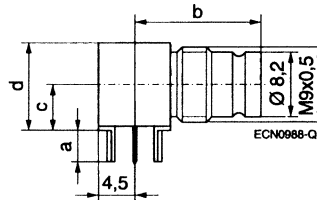

dimension a = 4 mm
b = 16 mm
c = 6 mm
d = 10,75 mm

pin arrangement for 2,54 mm grid

Coupling type style A: for push-screw coupling
Coupling type style B: for snap-on coupling (push-pull)
Coupling type style C: for slide-in coupling
Coupling type style F: for latching coupling (Quick Lock)

Outline drawing	Ordering code	DU					
		Pcs					
9	V23612-A1068-G1	25					
NEW 10	V23612-A1027-A1	25					
11	V23612-A1030-G5	40					
12	V23612-A1227-A1	40					

The miniature connectors comply with standards CECC 22120 and MIL-C-39012. They are suitable for use at frequencies up to 4 GHz. The typical 2-stud bayonet coupling provides a fast and simple handling. The construction follows the pin – socket principle, the inner conductor contacts, pins and jacks are of gold-plated brass, the inner conductors socket are made of gold-plated copper-beryllium alloy.

Outline drawing 1

Cable plug

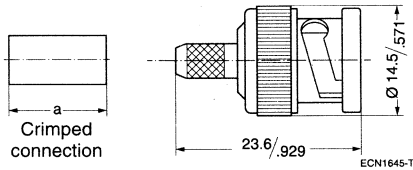

dimension a = 12,7 mm / 0,5 inch

Outline drawing 2

Cable angle plug

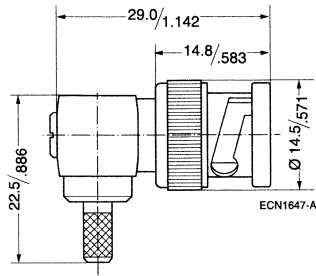

Outline drawing 3

Bulkhead jack with cable connection

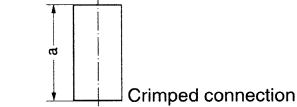
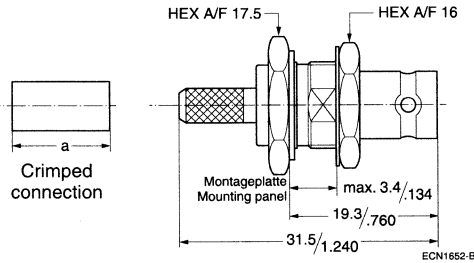

Outline drawing 4

Within-series adapter jack-jack

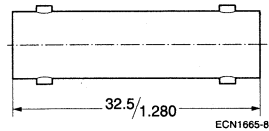

Connectors

Out-line drawing	Cable type	Ordering code	DU				
			Pcs				
1	02Y(St)CY 0,45/2,0	V23619-A102-A76	50				
2	02Y(St)CY 0,45/2,0	V23619-A202-A76	50				
3	02Y(St)CY 0,45/2,0	V23619-C602-A76	50				
4	-	V23609-A5100-A1	50				

Outline drawing 1

Standard termination (75 Ω)
1,6/5,6 mS plug
Coupling type style A

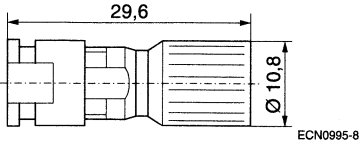

Outline drawing 2

Within-series adaptor (75 Ω),
Adaptor 1,6/5,6 mS, plug/plug
Coupling type style A

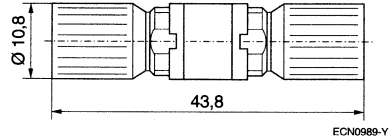

Outline drawing 3

Within-series adaptor (75 Ω)
Adaptor 1,6/5,6 mS plug/jack
Coupling type style A, B^{*)}, F^{*)}

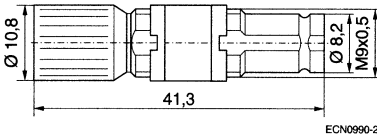

Outline drawing 4

Within-series adaptor (75 Ω)
Adaptor 1,6/5,6 mS, jack/jack
Coupling type style A, B, F

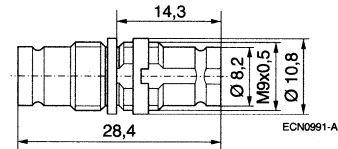

^{*)} only socket side

Coupling type style A: for push-screw coupling
Coupling type style B: for snap-on coupling (push-pull)
Coupling type style F: for latching coupling (Quick Lock)

Outline drawing	Power dissipation W	Ordering code	DU Pcs						
1	1,0	C42334-A82-A2	1						
2	—	C42334-A84-A2	1						
3	—	C42334-A84-A4	1						
4	—	V23612-B5100-G2	25						

Outline drawing 5

Inter-series adaptor (75 Ω)
Plug BNC to plug jack 1,6/5,6

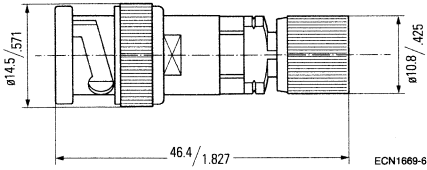

Outline drawing 6

Inter-series adaptor (75 Ω)
Plug BNC to jack 1,6/5,6

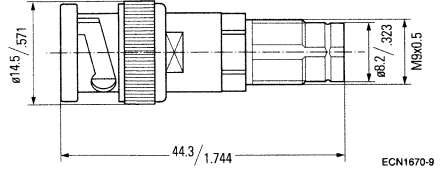

Outline drawing 7

Inter-series adaptor (75 Ω)
Jack BNC to plug 1,6/5,6

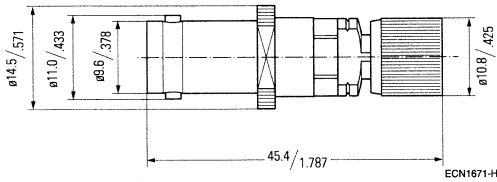

Outline drawing 8

Inter-series adaptor (75 Ω)
Jack BNC to jack 1,6/5,6

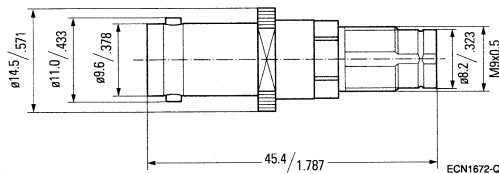

Connectors

Outline drawing	Ordering code	DU Pcs							
5	V23619-A5000-A2	1							
6	V23619-A5200-A3	1							
7	V23619-A5300-A1	1							
8	V23619-A5100-A3	1							

Crimping tool

For assembling coaxial connectors on coaxial cables.
Especially economical for small-volume production runs.

The crimping dies are a permanently attached part of the crimping tools.

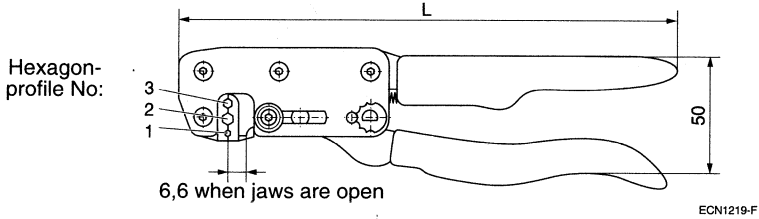

L = 260 mm

Hexagon-width of the profiles: 1 = 2,8 mm
2 = 5,4 mm
3 = 4,5 mm

Handle color: yellow

Item	Ordering code	DU Pcs								
Crimping tool	V23599-M1002-K2	1								

Product Group Index

	Seite
Switches and Pushbuttons	199
Mountings	215
Circuit breakers	217
Acoustic Signalling Devices	223

SIEMENS

We stay at the

heart of things

More and more mobile phones come fitted with a multichip module with HDI substrates or connector from Siemens Electromechanical Components. Which is hardly surprising: Our components are steadily getting smaller, more efficient – and are increasingly customer specified. The reason: We too stay at the heart of things. Customers are demanding our know-how earlier in the development process to help them turn innovative ideas into exciting new products.

Does that sound to you like the ideal way of working together? Then get in touch with us!



Components with system vision

Switches and Pushbuttons

Contents	Page
<hr/>	
Switches and pushbuttons for printed circuits	
Slide switches A68	200
Slide switches A60	202
Dual-in-line switches A3000	203
Single-deck rotary switches	205
Pushbutton switches A60	207
DIP-FIX links/Switches A1347	208
Solder link block LBB 126	209
Key switches STB 11	210
Keypops for STB 11	211
Keylock switches SPC 266 and SPC 758	212

Further technical documentation and information on our overall product range

CD-ROM „Connectors“, Ordering code A23001-G20-D013-X-7400
Data Book „Schalter und Tasten/Switches and Pushbuttons“,
ordering code A23001-G23-D009-X-7400
EC switches and pushbuttons in the Web: <http://www.siemens.de/ec/ecb>

Slide Switches A68 for Printed Circuits

Slide switches with 1 or 2 changeover contacts

Dust-protected or immersion-cleanable (version actuated from the top)
Switching mode: break

Tails suitable for center spacing 2,5 mm and 2,54 mm in acc. with DIN 40803

Actuated from the top

with 1 changeover contact

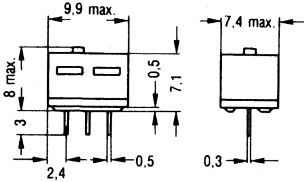

with 2 changeover contacts

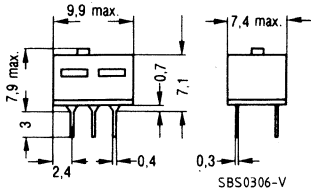

Travel
S = 2 mm

Actuated from the top or at the side

with 1 changeover contact

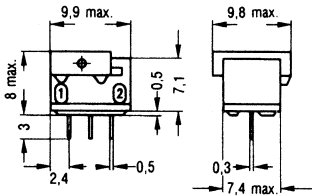

with 2 changeover contacts

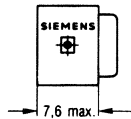
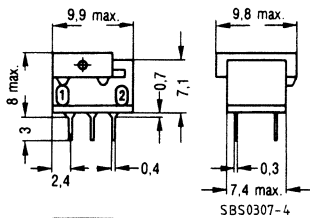

Actuated from the top, immersion-cleanable

with 1 changeover contact

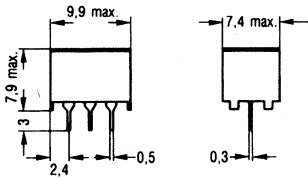

with 2 changeover contacts

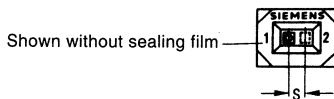
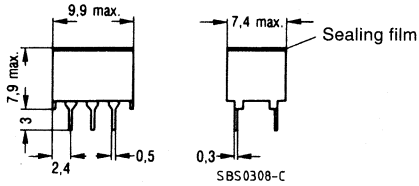

Travel
S = 2 mm

Slide Switches A68 for Printed Circuits

1 changeover contact



(Switch viewed from above)

2 changeover contacts

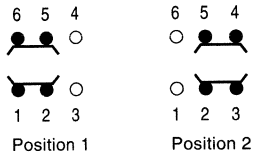

(Switch viewed from above)

Technical data

Contact materials
Stationary contact
Wiping contact

Voltage rating
Current rating
Switch capacity

Contact resistance (millivolt method); initial value
Insulation resistance; initial value
Ambient temperature range

nickel-plated and gold-plated
nickel-plated and gold-plated

≤ 24 Vdc/ac
 $\leq 0,3$ Adc/ac
 ≤ 3 VA¹⁾

≤ 40 m Ω
 $\geq 10^5$ M Ω
 $- 25 \dots + 85$ °C

Slide switch A68	Ordering code	DU							
		Pcs							
With 1 changeover contact, dust-protected									
Actuated from the top	C42315-A68-A3	80							
Actuated also at the side	C42315-A68-A4	80							
With 2 changeover contacts, dust-protected									
Actuated from the top	C42315-A68-A1	80							
Actuated also at the side	C42315-A68-A2	80							
With 2 changeover contacts, immersion-cleanable									
Actuated from the top	C42315-A68-A31	80							

1) Up to 100 switching cycles

Slide Switches A60 for Printed Circuits

Slide switches with 2 changeover contacts

Immersion-cleanable

Switching mode: break

Tails suitable for center spacing 2,5 mm and 2,54 mm in acc. with DIN 40803

Actuated from the top

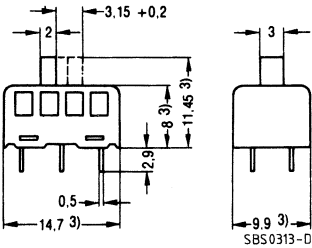

Actuated at the side

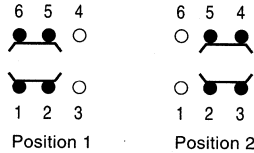
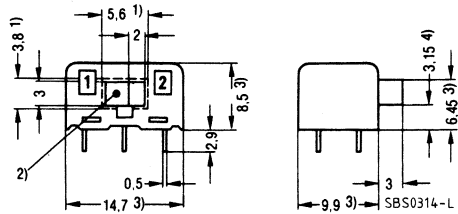

(Switch viewed from above)

Technical data

Contact materials
Stationary contact
Wiping contact

Voltage rating
Current rating
Switch capacity

Contact resistance (millivolt method)
Insulation resistance; initial value
Ambient temperature range

gold-plated
nickel-plated and gold-plated

≤ 60 Vdc/ac
≤ 0,5 Adc/ac
≤ 20 W

≤ 40 mΩ
≥ 10⁵ MΩ
- 25 ... + 85 °C

Slide switch A60	Ordering code	DU						
		Pcs						
Actuated from the top	C42315-A60-A24	80						
Actuated at the side	C42315-A60-A25	80						

- 1) Minimum front panel cut-out
- 2) Switch with red indicating dot upon request
- 3) Maximum dimension
- 4) Minimum dimension

Dual-in-line Switches A3000 for Printed Circuits



Dual-in-line switches with 3 to 10 on/off switches.
Single-pole; actuated individually and mutually independently.
Immersion-cleanable

Plug-in version

Tails suitable for center spacing
2,54 mm in acc. with DIN 40803

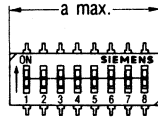
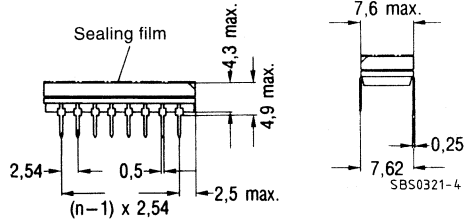

Shown without sealing film

n = number of switches
a = see next page

SMD version

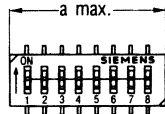
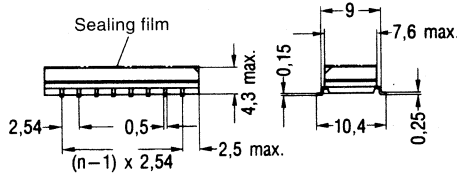

Shown without sealing film

Solder pad layout and possible packing density

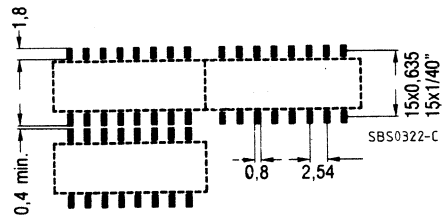

Technical data

Contact materials
Stationary contact
Wiping contact

Voltage rating
Current rating
Switch capacity

Contact resistance (millivolt method);

initial value
after stressing

nickel-plated and gold-plated
nickel-plated and gold-plated

≤ 24 Vdc/ac
 $\leq 0,5$ Adc/ac
 ≤ 5 VA

Insulation resistance; initial value
Ambient temperature range

≤ 50 m Ω
 ≤ 100 m Ω
 $\geq 10^3$ M Ω
 $-25 \dots +85$ °C

Dual-in-line Switches A3000 for Printed Circuits



Number of switches = n	Dimension a mm	Ordering code	DU										
			Pcs										

Plug-in version, tails straight

4	12,42	V23756-A3003-A4	40													
5	14,96	V23756-A3003-A5	30													
6	17,50	V23756-A3003-A6	25													
8	22,58	V23756-A3003-A8	22													
10	27,66	V23756-A3003-A10	18													

Plug-in version, tails straddled (15°)

8	22,58	V23756-A3001-A8	25													
---	-------	-----------------	----	--	--	--	--	--	--	--	--	--	--	--	--	--

SMD version

3	9,88	V23756-A3002-A3	60													
4	12,42	V23756-A3002-A4	50													
5	14,96	V23756-A3002-A5	40													
6	17,50	V23756-A3002-A6	35													
7	20,04	V23756-A3002-A7	30													
8	22,58	V23756-A3002-A8	25													
9	25,12	V23756-A3002-A9	25													
10	27,66	V23756-A3002-A10	20													



Note: Switches are supplied in position "ON" (contacts closed).

Single-deck Rotary Switch for Printed Circuits

Single-deck rotary switches BCD or hexadecimal coding (10 or 16 switch positions), without rotation limit. Switching mode: break.

Immersion-cleanable.

Tails suitable for center spacing 2,5 mm and 2,54 mm in acc. with DIN 40803

Rotary switch: Actuated from the top by screwdriver

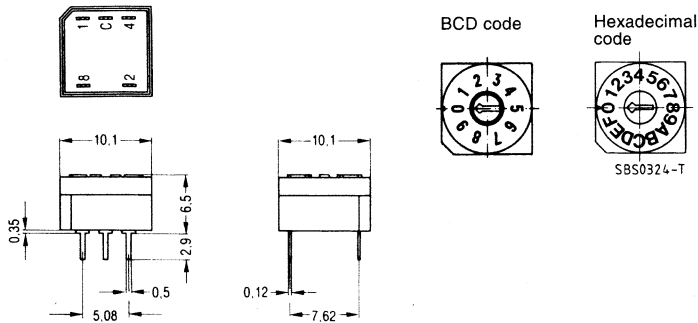

Rotary switch: Actuated from the top by screwdriver or by hand (knurled shaft)

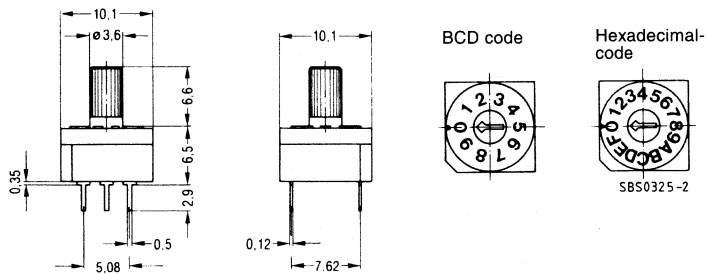

Rotary switch: Actuated from the top or at the side by screwdriver or by hand (indexing disk)

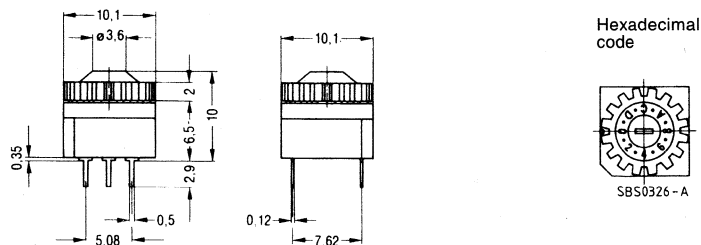

Single-deck Rotary Switch for Printed Circuits

Code table	Hexadezimal code												
	BCD code												
Terminal C connected to	Switch position												
	0	1	2	3	4	5	6	7	8	9	A B C D E F		
Terminal	1	x	x	x	x	x	x	x	x	x	x	x	x
	2		x	x		x	x				x	x	x
	4			x	x	x						x	x
	8						x	x			x	x	x

Terminal 8 connected to:

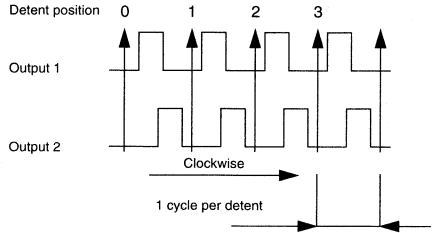

Terminals C and 4 without electrical function

ECN0029-5

Technical data

Contact materials
Switch wafer
Contact head

nickel-plated and gold-plated
nickel-plated and gold-plated

Voltage rating
Current rating
Switch capacity

≤ 24 Vdc/ac
≤ 0,2 Adc/ac
≤ 1,5 VA

Contact resistance (millivolt method);

initial value
after stressing

≤ 60 mΩ
≤ 100 mΩ

Insulation resistance;

initial value
after stressing

≥ 10⁵ MΩ
≥ 10² MΩ

Code	Ordering code	DU																	
		Pcs																	

Single-deck rotary switch
actuated from the top by a screwdriver

BCD code	C42315-A1353-A1	70																	
Hexadecimal code	C42315-A1353-A10	70																	

Actuated from the top by screwdriver or by hand (knurled shaft)

BCD code	C42315-A1353-A2	120																	
Hexadecimal code	C42315-A1353-A11	120																	

Actuated from the top and at the side by screwdriver or by hand (indexing disk)

Hexadecimal code	C42315-A1353-A12	120																	
------------------	------------------	-----	--	--	--	--	--	--	--	--	--	--	--	--	--	--	--	--	--

Pushbutton Switches A60 for Printed Circuits

Pushbutton switches with 2 changeover contacts

Switching mode: break

Tails suitable for center spacing 2,5 mm and 2,54 mm in acc. with DIN 40803

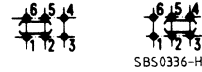
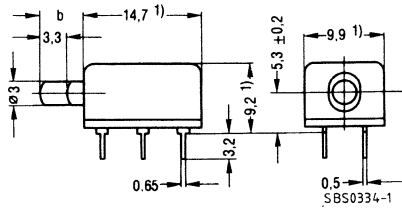

Idle position
Actuated position
(Switch viewed from above)

Dimension b = 5,4 mm or 9,4 mm

Minimum stroke for reliable switch-over 3,1 mm
Overall travel 3,5 mm

Technical data

Contact materials
Stationary contact
Wiping contact

Voltage rating
Current rating
Switch capacity

Contact resistance (millivolt method); initial value
Insulation resistance; initial value
Ambient temperature range

nickel-plated and gold-plated
nickel-plated and gold-plated
 ≤ 60 Vdc/ac
 $\leq 0,5$ Adc/ac
 ≤ 5 VA
 ≤ 20 m Ω
 $\geq 10^5$ M Ω
 $- 25 \dots + 85$ °C

Button length Dimension b	Ordering code	DU							
		Pcs							
5,4 mm	C42315-A60-A3	50							
9,4 mm	C42315-A60-A4	40							

1) Maximum dimension

DIP-FIX Links/Switches A1347 for Printed Circuits

DIP-FIX links/switches; multi-section

Tails suitable for center spacing 2,54 mm in acc. with DIN 40803

DIP-FIX make contacts (8 or 24-section in-line switches)

Plastic lug for holding the spring contact in the OFF position

Separating points, for individual switches

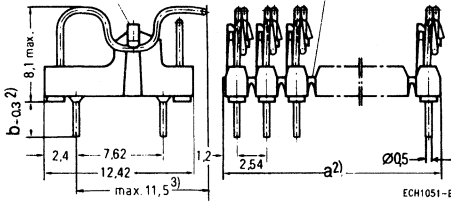

Circuit diagram and recommended coding for the connections (Example: 8 make contacts)

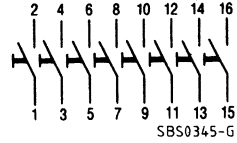

DIP-FIX changeover contacts (4 or 12-section in-line switches)

Separating points, for individual switches

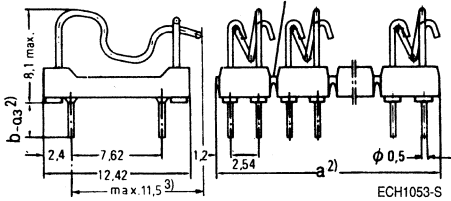

Circuit diagram and recommended coding for the connections (Example: 4 changeover contacts)

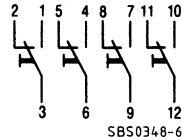

Technical data

Contact surface
Surface of the tails

Voltage rating
Current rating
Switch capacity

Contact resistance (millivolt method); initial value
Insulation resistance; initial value
Dielectric
Ambient temperature range

Sn Pb } whiskerproof
Sn Pb }

10 mV ... 60 V } connection not soldered¹⁾
≤ 0,5 A
≤ 5 VA

≤ 100 mΩ
≥ 10⁵ MΩ
PBTP-GF
- 40 ... + 85 °C

Switch	In-line switch sections	Dim. "a"	Dim. "b"	Ordering code	DU					
				C42315-	Pcs					
Make	8 units	20,32	3,1	A1347-A108	225					
	24 units	60,62	3,1	A1347-A124	75					
Change-over	4 units	20,32	3,1	A1347-A204	225					
	12 units	60,62	3,1	A1347-A212	75					

Other number of sections upon request.

1) Safeguarding the ON position is possible by manual soldering, if required
2) For dimensions »a« and »b« see ordering table
3) Maximum dimension

Solder Link Block 126

Solder link block LBB 126

Block of 24 snap-off solder links
Tails suitable for center spacing $2,54 \times 5,08$ mm

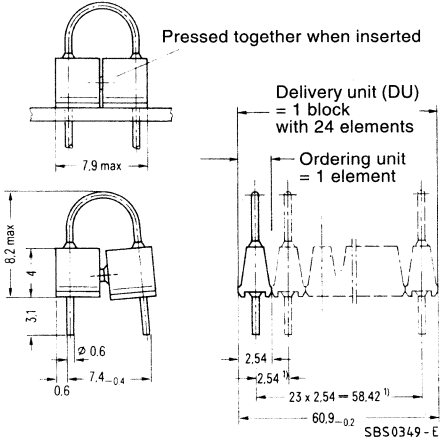

Technical data

Current rating per link at ambient temperature	+ 20 °C:	3 A
	+ 70 °C:	1,5 A
	+ 100 °C:	0,8 A
Dielectric strength		500 V/50 Hz
Insulation resistance; initial value		$\geq 10^4$ M Ω
Minimum interlink creepage distance		3 mm
Minimum interlink clearance		1,8 mm
Permissible temperature range		- 40 ... + 130 °C

Item	Ordering code	Deliv- ery unit (DU)							
Solder link	A126-A1	1200							

DU: 50 blocks with 24 elements

Note: Ordering code and price apply to 1 element. Available are only blocks with 24 elements each.

Key Switches STB 11 for Printed Circuits

Key switches STB 11 with 1 make contact or 1 changeover contact, 4 mm travel, for LED insert, without or with switching diode.

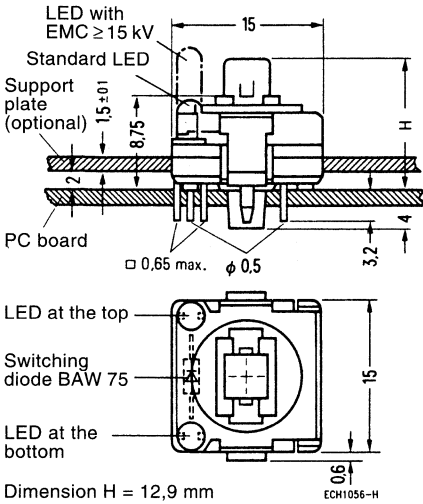

- 1) When locating the key in a support plate or with automated assembly, the hole diameters must be matched to the additional tolerances.
- 2) Recommendation: Use circular soldering holes if switching diode and LED are to be used.

Technical data

Contact surface – stationary contact
– moving contact

Voltage rating (open contact)
Current rating (resistive load)
Service life with electr. load 5 Vdc, 2 mA (resistive load)
Contact resistance (millivolt method)
Insulation resistance
Ambient temperature range

Mounting holes for changeover version, (component side)

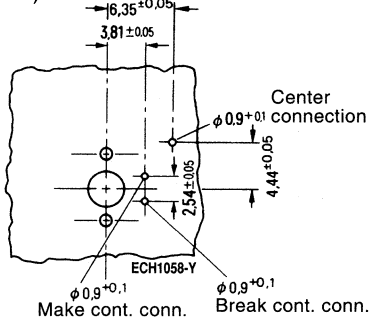

Mounting holes, additional holes for LED

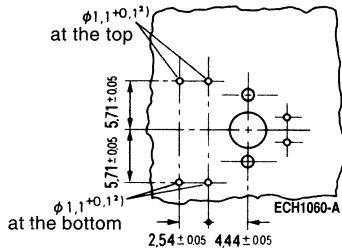

silver palladium
gold-flashed or gold-plated

12 Vdc
50 mAdc
make contact, non-detent $\geq 10^7$ cycles
changeover contact, non-detent $\geq 10^6$ cycles
< 500 m Ω ; initial value
> 10⁵ M Ω ; initial value
– 25 ... + 85 °C

Item	Ordering code	DU							
			Pcs						
Key switches STB 11, with 1 make contact									
without switching diode	V42263-D11-K1	160							
without switching diode, with detent	V42263-D11-K9	160							
with switching diode	V42263-D11-K5	160							
Key switches STB 11, with 1 changeover contact									
without switching diode	V42263-D15-K1	20							

Keypops for STB 11

Keypops without characters

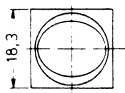
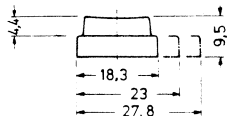

SBS0353-7

V23770-A1000-K1
Normal keytop

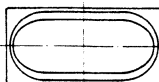
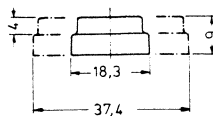

V23770-A9100-K1
Duplex keytop,
for guide pieces
see ordering table

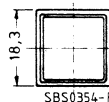

SBS0354-F

C26382-F302-C100
Keytop for lettering
insert, requires
cover
C26382-F302-C1

Note: Keypops with characters and other shapes of keytops available upon request.

Item	Ordering code	Note
Keypops, without characters – color light beige		
Normal	V23770-A1000-K1	Please note:
Duplex keytop Required guide pieces: 1 piece per keytop 2 pieces per keytop 2 pieces per keytop	V23770-A9100-K1 C26382-F300-C1 C26382-F300-C7 C26382-F300-C8	Manufacturing of the key caps has been handed over entirely to the company: INDIA-DREUSICKE Rigistraße 11 D-12277 Berlin Tel. (030) 723 700-0 Fax (030) 723 700-99.
For lettering insert Required cover (transparent)	C26382-F302-C100 C26382-F302-C1	Please direct your orders or enquiries directly to this company or to one of our specialist trade outlets.

Keylock Switches SPC 266 and SPC 758 for Printed Circuits

Keylock switch SPC 758 with 1 contact

With 1 locking position

Key rotation 90°
 Key removable in 1 position
 Different locks
 Without color ring and color button

For outline drawing and mounting holes see preceding page

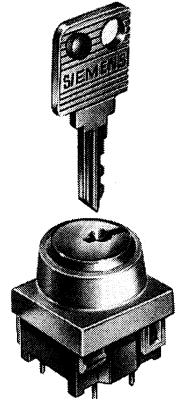
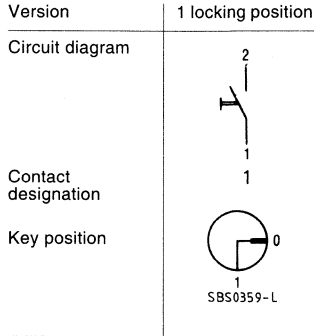

ECH1575-0

Technical data

Contact materials – stationary contact	gold-plated
– moving contact	gold-plated
Color	light beige
– cap	red (only for SPC 266)
– bezel and buttons	
Voltage rating	≤ 48 Vdc/ac
Current rating	≤ 50 mA
Switch capacity	≤ 1 VA
Service life at 1 VA resistance value	≥ 20 000 cycles
Contact resistance (millivolt method); initial value	< 60 mΩ
Insulation resistance; initial value	> 10 ⁵ MΩ
Ambient temperature range	– 25 ... + 85 °C

Version (2 keys per lock)	Ordering code	DU							
		Pcs							

Keylock switches SPC 266, different locks

1 locking position	V42266-C3000-B122	5							
2 locking positions	V42266-C3000-C125	5							

Keylock switches SPC 266, identical locks

1 locking position	V42266-C4001-B122	5							
2 locking positions	V42266-C4001-C125	5							

Spare key for SPC 266, identical locks

Lock no. EB 4001	V42266-Z4001-S	1							
------------------	----------------	---	--	--	--	--	--	--	--

Keylock switches SPC 758

1 locking position	V23758-B2000-K111	5							
--------------------	-------------------	---	--	--	--	--	--	--	--

Mountings

Contents

Page

Mounting fixtures for resistors and capacitors

216

Further technical documentation and information on our comprehensive product range

Data Book „Steckverbinder/Connectors DIN 41617 ... 622; Meßsteckverbinder/Connectors for measuring“, ordering code A23001-G21-D020-X-7400
EC connectors in the Web: <http://www.siemens.de/ec/ecb>

Mounting Fixtures for Resistors and Capacitors

For printed circuits

For horizontal arrangement

for small-sized components

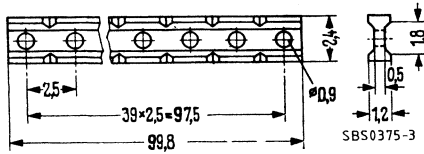

for medium-sized components

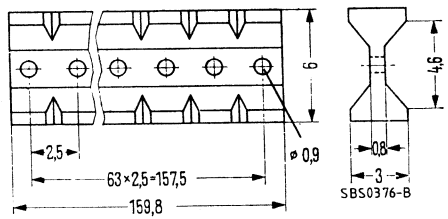

The mounting fixtures can be divided into lengths to match the components.

Mounting fixture	Ordering code	DU				
		Pcs				
For resistors and capacitors						
of small size	C42121-A40-C14	1000				
of medium size	C42121-A40-C15	1000				

Circuit breakers

Contents	Page
Thermal circuit breakers W28	218
Thermal circuit breakers W58	219
Magnetic-hydraulic circuit breakers W6/W9	220

New in this edition

Thermal circuit breakers W28 and W58

Thermal circuit breakers are an economical alternative to standard fuses. They are used in domestic as well as in industrial applications, e.g. in medicinal equipment, power supplies, heating and air-conditioning equipment, computers, mains outlet protection etc.

These components are mounted on equipment front panels. The circuit breakers are equipped with a reset button or key. A tripped overcurrent release is indicated by the fact that the reset button or key has popped up. It is not possible to trip the overcurrent release manually.

Magnetic-hydraulic circuit breakers W6/W9

These are required for overcurrent protection of cables, components, mains outlets etc. They are mainly used in equipment for industrial applications, e.g. medicinal equipment, retail slot machines, central heating and air-conditioning plants, power supplies, computers- and telecommunications equipment.

These circuit breakers have screw terminals. The "ON" and "OFF" status indication is given by corresponding markings at the base of the switch lever of the W6 and by markings on the switch lever of the W9.

POT:W28

for dc or ac voltage,
1 make contact

For snap-in mounting
in front panels with a thickness
0,8 mm to 1,6 mm

Trigger point cannot be influenced

Terminals for 6,35 mm
push-on connectors

Approvals: VDE, UL, CSA

Approx. weight 10 g

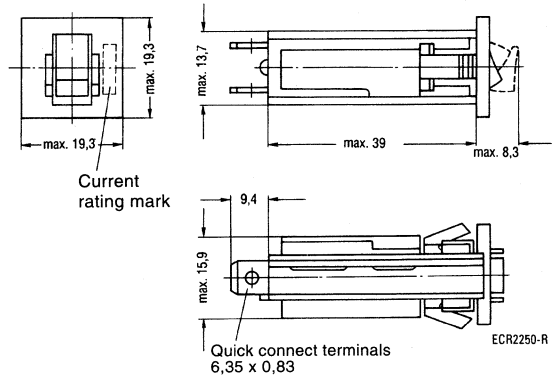

Mounting hole layout (recommended)

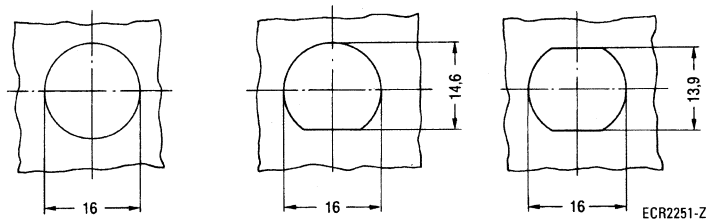

Trigger behavior
at an ambient temperature of 23°C

100% rated current, no release
135% rated current within 60 minutes
200% rated current within 2,20 ... 15 s
600% rated current within 0,27 ... 0,7 s

Dielectric strength
Maximum operating voltage

1500 Vac rms
32 Vdc, 250 Vac

Max. resistance:
rated current 5 A
rated current 10 A
rated current 15 A

0,030 Ω
0,011 Ω
0,007 Ω

Resettable overload capacity
Reset time
Electrical endurance

6 times rated current
max. 60 s
1000 switching cycles at 200% rated current

Rated current	Ordering code	DU				
A		Pcs				
◆ 5	POT:W28-XQ1A-5	100				
◆ 10	POT:W28-XQ1A-10	100				
◆ 15	POT:W28-XQ1A-15	100				

POT:W58

for dc or ac voltage,
1 make contact

For mounting in front panels

Trigger point cannot be influenced

Terminals for 6,35 mm push-on connectors

Approvals: UL, CSA

Approx. weight 42 g

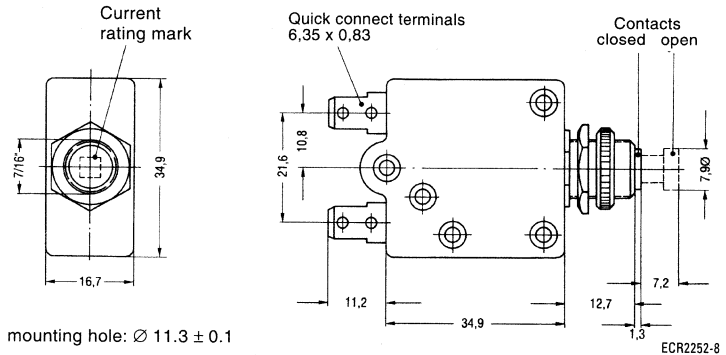

mounting hole: $\varnothing 11.3 \pm 0.1$

Trigger behavior
at an ambient temperature of 23°C

100% rated current, no release
145% rated current within 60 minutes
200% rated current within 6,0 ... 30 s
600% rated current within 0,6 ... 1,7 s

Dielectric strength
Maximum operating voltage

1500 Vac rms
50 Vdc, 250 Vac

Maximum resistance:

rated current 5 A 0,026 Ω
rated current 10 A 0,014 Ω
rated current 15 A 0,006 Ω

Electrical endurance

1000 switching cycles at 200% rated current

Rated current	Ordering code	DU					
A		Pcs					
◆ 5	POT:W58-XB1A4A-5	100					
◆ 10	POT:W58-XB1A4A-10	100					
◆ 20	POT:W58-XB1A4A-20	100					

Elektrom. Bauteile

POT:W6 single pole

for dc or ac voltage,
1 make contact

Toggle switch lever for operation, white

For screw mounting

Terminals for 6,35 mm
push-on connectors

Approvals: VDE, UL, CSA

Approx. weight 70 g

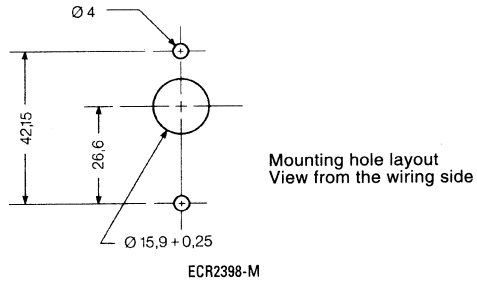
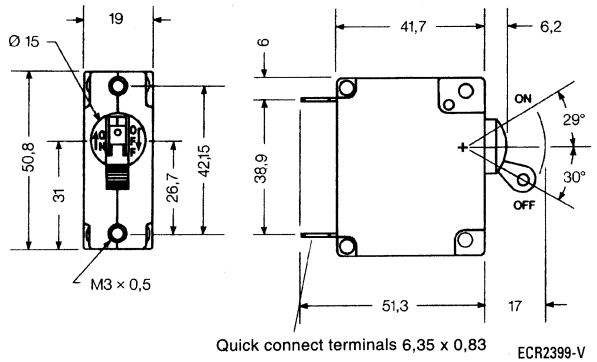

POT:W9 single pole

for dc or ac voltage,
1 make contact

Toggle switch lever for operation, black

For screw mounting

Screw terminals,

Approvals: VDE, UL, CSA

Approx. weight 70 g

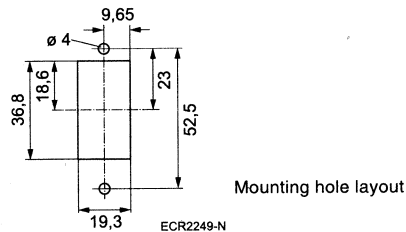
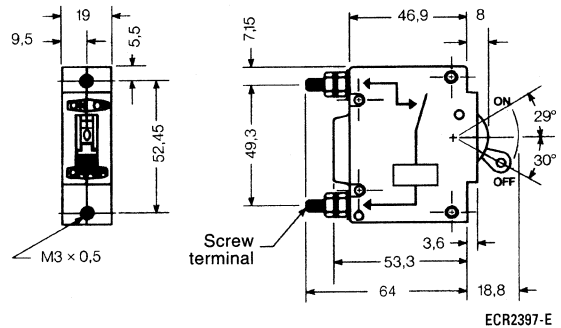

Trigger behavior: 100% rated current, no release
 135% rated current within 1 min. ... 90 s
 200% rated current within 0,60 ... 20 s
 600% rated current within 0,02 ... 0,95 s

Dielectric strength 1100 Vdc
 1500 Vac rms, 50/60 Hz

Typical resistance:
 rated current 5 A 0,04 ± 20 % Ω
 rated current 10 A 0,013 ± 25 % Ω
 rated current 20 A 0,005 ± 30 % Ω

Maximum operating voltage 65 Vdc, 250 Vac
 Permissible ambient temperature - 40 bis + 85 °C
 Electrical endurance 6000 switching cycles at rated current

Rated current	Ordering code	DU																	
A		Pcs																	

Circuit breakers W6

◆ 5	POT:M67-X2Q734-5	72																	
◆ 10	POT:M67-X2Q734-10	72																	
◆ 20	POT:M67-X2Q734-20	72																	

Circuit breakers W9

◆ 5	POT:M91-X1734-5	55																	
◆ 10	POT:M91-X1734-10	55																	
◆ 20	POT:M91-X1734-20	55																	

Elektrom. Bauteile

Acoustic Signalling Devices

Contents	Page
Horn HF2 for outdoor applications	224
Horn HT1 for dry environments	225
High-intensity bell GF1 for outdoor applications	226
High-intensity bell GF2 for outdoor applications	227
High-intensity bell GT2 for dry environments	228

Further technical documentation and information on our overall product range

Technical List Kg "Akustische Signalgeräte", ordering code A23999-A314-A999-★-04

Horn HT1 for Dry Environments (Low-Profile Horn)

V23302-A★★★ for ac operation 50/60 Hz

Mounting position as required,
preferably in vertical position

Approx. weight: 1,4 kg

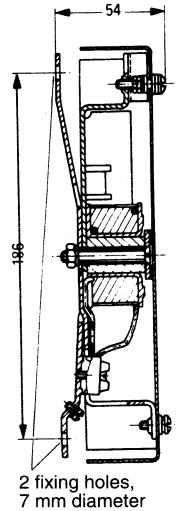
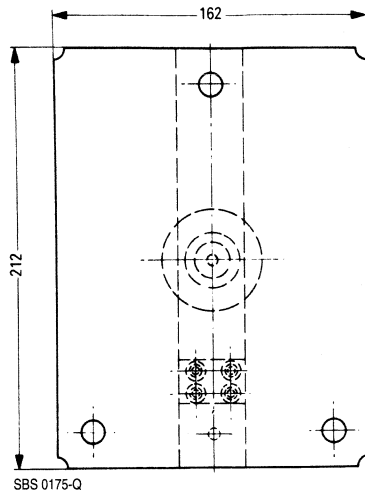

Cover	pebble grey lacquer coating
Power consumption	approx. 50 VA
Mode of operation	short-time duty (KB 5) max. 5 minutes
Sound output at 1 m distance	approx. 100 dB (A), adjustable
Protection class (DIN 40050)	IP 20
EMI/RFI suppression	class N

Approvals

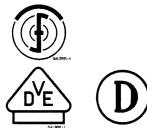

Operating voltage	Ordering code	Delive- ry unit		
Vac		Pcs		
220	V23302-A2011	1		

High-Intensity Bell GF1 for Outdoor Applications

V23301-A★★★/B★★★
High-speed dc or ac operation
50/60 Hz
or ringing current 25 Hz

Mounting position as required,
 preferably in vertical position
 Approx. weight: 2 kg or 2,5 kg

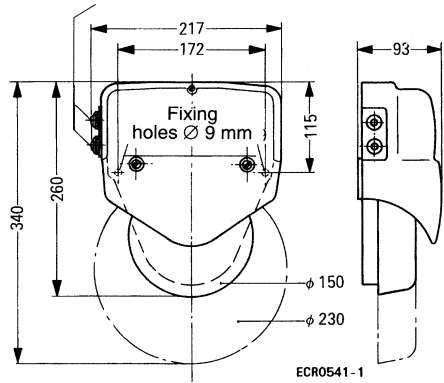

Bell	sheet steel, bright-zinc coated, yellow passivation in chromatic acid, silver-grey, metallic lacquer coating
Base plate	glass-fiber reinforced thermosetting plastic, black inking, cover with rubber-ring packing
Cover	thermosetting plastic, pebble-grey, Bunsen-burned surface
Power consumption or response power	approx. 2,5 VA or 4,5/6 W approx. 0,06 VA
Sound output at 1 m distance	approx. 80 dB (A) or 100 dB (A)
Protection class (DIN 40050)	IP 64
EMI/RFI suppression	class N



approvals
 (only for 50 Hz)



Operating voltage	Se-quence of strokes/s	EMI/RFI suppres-sion class N	Ordering code	Delive-ry unit		
			V23301-	Pcs		
Bell Ø 150 mm						
24 Vdc	60		A3104-A24	1		
110 Vac	60	×	A3102-A110	1		
220 Vac	50	×	A3101-A220	1		
15 ... 75Vac (25 Hz ringing current) *)	25	×	A3106-X3	1		
Bell Ø 230 mm						
220 Vac	50	×	B3101-A220	1		
220 Vac (25 Hz ringing current) **)	50	×	B3101-C220	1		
24 Vdc (single stroke, ext. clock)	6 max.	×	B3104-F24	1		

*) With incorporated capacitor 1 µF, approved by Federal Postal Administration for private branch exchanges.

**) With incorporated control circuit (relay), approved by Federal Postal Administration for private branch exchanges.

High-Intensity Bell GF2 for Outdoor Applications

V23301-A★★★
High-speed ac operation
50/60 Hz
 Vertical mounting position
 Approx. weight: 1,5 kg

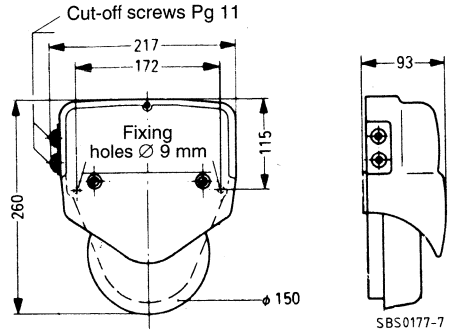

Bell	sheet steel, bright-zinc coated, yellow passivation in chromatic acid, silver-grey, metallic lacquer coating
Base plate	glass-fiber reinforced thermosetting plastic, dyed black
Cover	thermosetting plastic, pebble-grey, Bunsen-burned surface
Power consumption	approx. 12 VA
Striking sequence	50 or 60 strokes/s
Sound output at 1 m distance	approx. 105 dB (A)
Protection class (DIN 40050)	IP 33
EMI/RFI suppression	class N

Approvals



Operating voltage	Ordering code	Delivery unit		
Vac		Pcs		
24	V23301-A4103-A24	1		
220	V23301-A4103-A220	1		

High-Intensity Bell GT2 for Dry Environments

V23301-A★★★

**High-speed ac operation
50/60 Hz**

Vertical mounting position,
striker-screw facing downwards

Approx. weight: 1,2 kg

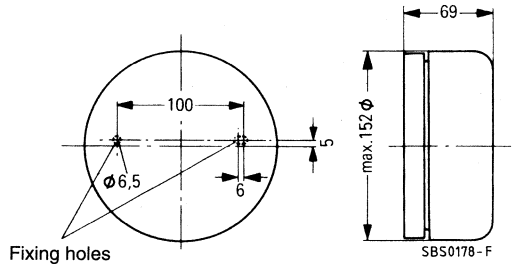

Bell	aluminum-bronze
Base of synthetic material	black
Power consumption	approx. 12 VA
Striking sequence	50 or 60 strokes/s
Sound output at 1 m distance	approx. 105 dB (A)
Protection class (DIN 40050)	IP 30
EMI/RFI suppression	class N



Approvals



Operating voltage	Ordering code	Delive- ry unit		
Vac		Pcs		
24	V23301-A5103-A24	1		
220	V23301-A5103-A220	1		

Survey

	Page
Alphanumerical Index	230
Terms of Business	233
Ordering Addresses	234

Alphanumerical Index

Type	Page	Type	Page
A1347	208	LBB 126	209
A1353	205	MR28★★★	105
A3000	203	MR78★★★	105
A60	202, 207	MR7★★★	105
A68	200	MT2★★★	101
BK-DIL 368	150	MT3★★★	101
BK-DIL 390	152	MTM★★★	103
BK-DIN 389	156	PC 612	124
BK-LEV 413	154	PE0★★★	53
BK-MOD 421/422	158	POT:M67	221
C26382-F★★★	211	POT:M91	221
C42121-A40	216	POT:T92	106
C42195-A126	209	POT:T9A	92
C42315-A1347	208	POT:W28	218
C42315-A1353	206	POT:W58	219
C42315-A60	202, 207	PT1★★★	100
C42315-A68	201	PT2★★★	96, 100
C42334-A100	185, 186	PT3★★★	96
C42334-A228	183, 184	PT5★★★	96
C42334-A282	187	PT7★★★	98
C42334-A285	188	RE0★★★	55
C42334-A30★	182, 186	RN7★★★	105
C42334-A347	141	RP 300	182
C42334-A368	151	RP 618	178
C42334-A386	155	RP 622	180
C42334-A389	157	RP1★★★	78
C42334-A390	153	RP2★★★	78
C42334-A40	181	RP3★★★	70
C42334-A41	181	RP3SL★★★	72
C42334-A42	181	RP4★★★	70, 75
C42334-A421	161, 162	RP7★★★	68, 70, 77
C42334-A422	162	RP8★★★	70, 75
C42334-A43	181	RPM★★★	78, 100
C42334-A44	181	RT1★★★	61, 69
C42334-A47	179	RT3★★★	61, 64
C42334-A48	179	RT33K★★	67
C42334-A49	179	RT4★★★	61, 64
C42334-A82	194	RT7★★★	68, 77
C42334-A84	194	RTE★★★	61
C42334-Z61	149	RTH★★★	66
GF1	226	RY1★★★	58, 69, 78
GF2	227	RY2★★★	56
GT2	228	RY5★★★	56
HF2	224	RY7★★★	58
HT1	225		

Type	Page	Type	Page
SIE:T7N	90	V23100-V43★★	46, 47
SPC 266	212	V23100-V6★★★	48
SPC 758	212	V23100-W12★★	24
STB 11	210	V23101-D★★★	23
Sub-D	163	V23104-A★★★	22
V23003-A★★★	37	V23105-A★★★	20
V23003-B★★★	37	V23106-J2★★★	17
V23005-A★★★	41	V23106-L2★★★	17
V23005-B★★★	41	V23107-S★★★★	116
V23006-G★★★	49	V23148-A★★★	82
V23006-H★★★	50	V23148-B★★★	84
V23006-Z★★★★	44	V23154-C★★★	29
V23009-A★★★	51	V23154-D★★★	30
V23016-A★★★	86	V23154-M★★★	32
V23016-B★★★	87	V23154-N★★★	32
V23016-C★★★	88	V23154-Z1★★★★	44
V23016-D★★★★	89	V23162-A★★★	34
V23026-A1★★★★	11	V23162-B★★★	35
V23026-B1★★★★	11	V23301-A3★★★★	226
V23026-C1★★★★	11	V23301-A4★★★★	227
V23026-D1★★★★	13	V23301-A5★★★★	228
V23026-E1★★★★	13	V23301-B3★★★★	226
V23026-F1★★★★	13	V23302-A2★★★★	225
V23030-A★★★★	25	V23302-C4★★★★	224
V23030-C★★★	27	V23529-A1111	171
V23030-H★★★	25	V23529-A1115	171
V23030-J★★★	27	V23529-A1223	171
V23040-A★★★	18	V23529-B1121	169
V23040-B★★★	18	V23529-B1223	169
V23040-C★★★	18	V23533-B1200	131, 133
V23047-A1★★★★	109	V23533-B1700	135
V23049-B1★★★★	111	V23533-B1736	135
V23050-A1★★★★	113	V23533-B2207	132, 134
V23054-D★★★	39	V23533-B2251	132, 134
V23054-E★★★	39	V23533-B2702	137
V23057-A★★★	79	V23533-B2715	137
V23057-B★★★	80	V23533-B2770	137
V23061-A1★★★★	59	V23535-P2263	132
V23061-B1★★★★	59	V23535-A1200	161
V23077-A★★★	73	V23535-A1210	161
V23079-A1★★★★	15	V23535-A2200	162
V23079-B1★★★★	15	V23535-A2210	162
V23079-C1★★★★	15	V23535-A3280	162
V23092-A1★★★★	54	V23535-B1780	155
V23100-S★★★	114	V23599-M★★★	196
V23100-V40★★	45	V23600-A1★★★★	188
		V23600-A2★★★★	189

Type	Page	Type	Page
V23601-A★★★★	142	V42254-B2535	130
V23601-B★★★★	142	V42254-P2263	128
V23609-A★★★★	193	V42263-D11	210
V23612-A1★★	190, 192	V42263-D15	210
V23612-A2★★	191	V42266-C3000	213
V23612-A6★★	190	V42266-C4001	213
V23612-A8★★	190, 191	V42266-Z4001	213
V23612-B★★★★	194		
V23614-A1★★	189	ZG2★★★★	100
V23614-A6★★	189	ZG7★★★★	98
V23615-B★★★★	144	ZT2★★★★	94
V23619-A1★★	193	ZT5★★★★	94
V23619-A2★★	193		
V23619-A5★★	195		
V23619-C602	193		
V23756-A3001	204		
V23756-A3002	204		
V23756-A3003	204		
V23758-B2000	213		
V23770-A1000	211		
V23770-A9100	211		
V42254-A1115	164		
V42254-A112	176		
V42254-A122	177		
V42254-A132	177		
V42254-A142	177		
V42254-A152	177		
V42254-A162	176		
V42254-A2115	164		
V42254-A2216	165		
V42254-A262	176		
V42254-A3226	167		
V42254-A4000	173		
V42254-A5235	173		
V42254-A6000	175		
V42254-A61★★	175		
V42254-A62★★	176		
V42254-B1200	124, 126, 129, 138		
V42254-B1201	147		
V42254-B1202	124, 126, 145, 147		
V42254-B2200	146, 148		
V42254-B2201	125, 127, 128		
V42254-B2202	125, 127, 128, 140		
V42254-B2235	128		
V42254-B2240	125, 128		
V42254-B2501	130		
V42254-B2502	130		

Terms of Business

The SCS catalog presents the preferred products from our extensive range of electromechanical components. Information on the complete product spectrum including technical details can be found in the relevant data books or be obtained from the Siemens Sales Offices (Electromechanical Components Group), Representatives or Distributors.

With the publication of the SCS Catalog "Preferred Products 1999" all previous editions become invalid.

If you have any questions on technical matters, prices, terms of delivery and payment, or in case of complaints, contact your nearest Siemens Sales Office (Electromechanical Components Division), Representative or Distributor. This also applies to returns of components, which can only be accepted if previously agreed upon. Quantities without original packings or parts cut off the tape (e. g. SMDs) are excluded from return.

In case of justified claims against purchaser, based on patent rights of third parties concerning electronic components or subassemblies supplied by us, we shall be obligated – as far as such claims refer to the components/subassemblies per se and not to their application or to circuits implemented within the components – at our sole option and expense to obtain the right of use or to modify or exchange the components/subassemblies or, if this should be impos-

sible or cannot reasonably be required, to take back the components/subassemblies and to reimburse the purchase price. This applies provided that the purchaser will inform us without delay and will not admit such claims. Any other claims are excluded, except where liability is enforced by law in cases of intent or gross negligence by us.

Due to technical requirements, components may contain dangerous substances. Information on individual products and on compulsory marking as prescribed by the Clear-Air-Act (USA) will be provided by your nearest Siemens Office, Electromechanical Components Division.

The information in this SCS Catalog describes the type of component and shall not be considered as assured characteristics.

Export: Export of goods or technical papers is only possible on the condition that there are no obstacles to the performance of the deliveries and services arising either from German or any other export regulations (e. g. in view of the intended use).

If products contained in this catalog are subject to export licensing, they are especially marked.

Furthermore the General Conditions of Supply and Delivery for Products and Services of the Electrical and Electronic Industry shall apply.

Issued by Siemens
Electromechanical Components GmbH & Co. KG
Gustav-Heinemann-Ring 212, D-81739 München

<http://www.siemens.de/ec>

Your distributor in the Benelux

EurodisTexim Electronics B.V

Nijverheidsstraat 16
Postbus 172
NL-7480 AD Haaksbergen
Tel. +(31) 53 57-33 333
Fax +(31) 53 57-33 888

EurodisTexim Electronics N.V/S.A.

Oorlogskruisenlaan 116
Avenue des Croix de Guerre 116
B-1120 Brussel/Bruxelles
Tel. +(32) 2-247 4969
Fax +(32) 2-215 8102

